

*This past question was successful uploaded by **Olanik Consultancy**. You can also visit the site www.myedugist.com for latest information on Examination, Education and Scholarships worldwide.*

Physics

1983-2004

JAMB

Questions

Physics 1983

1. In a resonance tube experiment, a tube of fixed length is closed at one end and several tuning forks of increasing frequency are used to obtain resonance at the open end. If the tuning fork with the lowest frequency which gave resonance had a frequency f_1 and the next tuning fork to give resonance had a frequency f_2 , find the ratio f_2/f_1 .
- A. 8 B. 3
C. 2 D. $\frac{1}{2}$
E. $\frac{1}{3}$

2. Which of the following is NOT a vector quantity?
- A. Force B. Altitude
C. Weight D. Displacement
E. Acceleration.

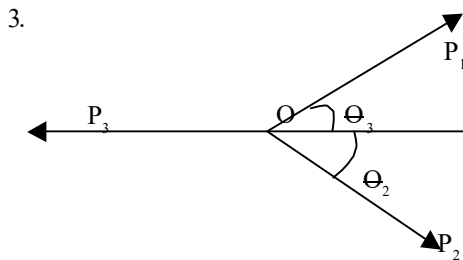

Fig. 1

Consider the three forces acting at O and in equilibrium as shown in Fig. 1. Which of the following equations is/are CORRECT?

- I. $P \cos \theta_1 = P_3 \cos \theta_2$
II. $P^1 = P \cos \theta_1 + P_3 \cos \theta_2$
III. $P^3 \sin \theta_1 = P_1 \sin \theta_2$

- A. I only B. II only C. III only
D. II and III only E. I and III only

Which of the following statements about friction is NOT correct?

- A. The force of kinetic friction is less than the force of static friction.
B. The force of kinetic friction between two surfaces is independent of the areas in contact provided the normal reaction is unchanged.
C. The force of rolling friction between two surfaces is less than the force of sliding friction.
D. The angle of friction is the angle between the normal reaction and the force friction.
E. Friction may be reduced by lubrication.

5.

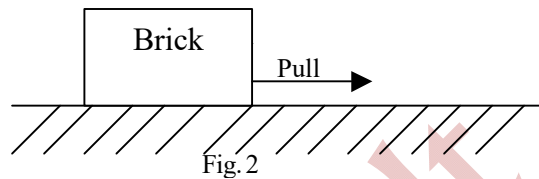

A brick at rest on a horizontal table is pulled by a horizontal cord, as shown in Fig. 2. The force of friction on the brick

- A. Increase if the pull increases but the brick does not move.
B. Is directly horizontal to the right
C. Decreases if an identical brick is placed on the first.
D. Is zero if the brick is pulled hard enough to make it slide.
E. Change if the brick is turned on its side.

6. The force with which an object is attracted to the earth is called its
- A. Acceleration B. Mass
C. Gravity D. Impulse
E. Weight.

7. The refractive index of a liquid is 1.5. If the velocity of light in vacuum is $3.0 \times 10^8 \text{ m s}^{-1}$, the velocity of light in the liquid is

- A. $1.5 \times 10^3 \text{ m s}^{-1}$
B. $2.0 \times 10^3 \text{ m s}^{-1}$
C. $3.0 \times 10^3 \text{ m s}^{-1}$
D. $4.5 \times 10^3 \text{ m s}^{-1}$
E. $9.0 \times 10^3 \text{ m s}^{-1}$

8. If the relative density of a metal is 19, what will be the mass of 20 cm^3 of the metal when immersed in water?

- A. 380g B. 400g
C. 360g D. 39g
E. 180g

9. Which of the following statements about liquid pressure is NOT correct? The pressure

- A. At a point in a liquid is proportional to the depth.
B. At any point in a liquid is the same at the same level.
C. Is exerted equally in all directions at any point.
D. Of a liquid at any point on the wall of its

- container acts in a direction perpendicular to the wall.
- E. At a particular depth depends on the shape of the vessel.
10. A ship traveling towards a cliff receives the echo of its whistle after 3.5 seconds. A short while later, it receives the echo after 2.5 seconds. If the speed of sound in air under the prevailing conditions is 250m s^{-1} , how much closer is the ship to the cliff?
 A. 10 m B. 125 m
 C. 175 m D. 350 m
 E. 1,000m
11. Which of the following is NOT correct?
 I. The pitch of a sound note depends on the frequency of vibrations.
 II. The intensity of a sound note is proportional to the amplitude of vibrations.
 III. Beats are produced by two sources of sound because one wave is travelling faster than the other.
 IV. When two sources of sound of frequencies 500 Hz and 502 Hz are sounded together, a beat frequency of 2 Hz is observed.
 V. The first harmonic of a note has double the frequency of the fundamental note.
 A. I and II B. II and III
 C. I and II D. III and IV
 E. IV and V.
12. Which of the following statements about defects of vision is/ are CORRECT
 I. For a long sighted person, close objects appear blurred.
 II. For a short sighted person, distant objects appear blurred.
 III. Short sight is corrected by using a pair of converging lenses.
 A. I only B. II only
 C. I and II only
 D. II and III only
 E. I, II and III.
13. The range of wavelengths of the visible spectrum is $400\text{nm} - 700\text{nm}$. The wavelength of gamma rays is
 A. Longer than 700nm
 B. Shorter than 700nm but longer than 400nm
 C. 550nm
 D. Shorter than 400nm
 E. Infinite
14. If the pressure on 1000cm^3 of an ideal gas is doubled while its Kelvin temperature is halved, then the new volume of the gas will become
 A. 25cm^3 B. 50cm^3
 C. 100cm^3 D. 200cm^3
 E. 400cm^3
15. A train has an initial velocity of 44m/s and an acceleration of -4m/s^2 . Its velocity after 10 seconds is
 A. 2m/s B. 4m/s
 C. 8m/s D. 12m/s
 E. 16m/s .
16. Which of the following conditions are necessary and sufficient for total internal reflection to take place at the boundary between two optical media?
 I. Light is passing from optically denser medium to optically less dense medium.
 II. Light is passing from optically less dense medium to optically denser medium.
 III. Angle of incidence is greater.
 IV. Angle of incidence is lesser.
 A. I and II only
 B. II and III only
 C. III and IV only
 D. I and III only
 E. II and IV only
17. A man of mass 50kg ascends a flight of stairs 5m high in 5 seconds. If acceleration due to gravity is 10m s^{-2} , the power expended is
 A. 100W B. 300W
 C. 250W D. 400W
 E. 500W
18. Which of the following arrangements in the sequence shown can be used to obtain a pure spectrum of white light?
 A. Source, slit, converging lens, prism, converging lens, screen.
 B. Source, slit, diverging lens, screen.
 C. Source, converging lens, prism, diverging lens, screen.
 D. Source, slit, prism, diverging lens, screen
- 19.

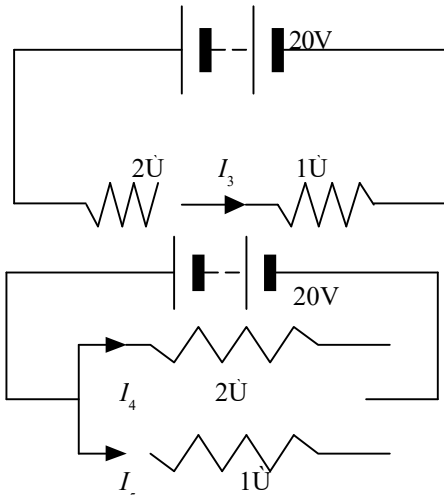

Fig. 3.

The diagrams in Fig.3 show three circuits. The internal resistances of the batteries are negligible. Which of the currents is the largest?

- A. I_1 B. I_2
 C. I_3 D. I_4
 E. I_5

20. A millimeter with full scale deflection of 100mA has an internal resistance of 5 ohms. It would be converted to an ammeter with a full scale deflection

- A. $\frac{1}{99}$ ohm in series with it
 B. $\frac{1}{99}$ ohm in parallel with it
 C. $\frac{99}{5}$ ohm in parallel with it
 D. $\frac{99}{5}$ ohm in series with it
 E. 2 ohms in series with it

21. It is usual to transmit electric power at high voltage and low current. Which of the following are possible advantages of the method.

- I Heat losses are reduced because the currents are small.
 II Thin wires can be used because small currents are flowing.
 III The power can flow faster because the voltage is high.
- A. I only
 B. I and II only
 C. II and III only
 D. I and III only
 E. I, II and III.

22. The linear expansivity of brass is $2 \times 10^{-10} \text{C}^{-1}$. If the volume of a piece of brass is 100cm^3 at 0°C , what will be its volume at 100°C ?

- A. 10.02cm^3 B. 10.04cm^3
 C. 10.06cm^3 D. 10.20cm^3
 E. 102.00cm^3

23. A 24V potential difference is applied across a parallel combination of four 6-ohm resistors. The

currents in each resistor is

- A. 1 A B. 4 A
 C. 16 A D. 18 A
 E. 36 A

24. In the circuit shown in Fig. 4, T is a resistor whose resistance falls as temperature increases. L_1 and L_2 are lamps. Assuming the cell has negligible internal resistance, as the temperature of T increases

- A. L_1 becomes brighter, L_2 becomes dimmer.
 B. L_1 and L_2 becomes brighter.
 C. L_1 becomes dimmer, L_2 becomes brighter.
 D. L_1 becomes brighter, L_2 does not change.
 E. L_1 becomes dimmer, L_2 does not change.

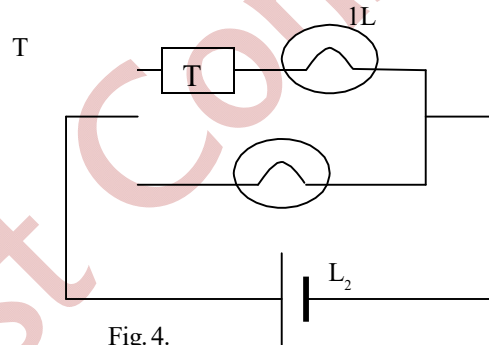

Fig. 4.

25. Which of the diagrams in Fig. 5 gives the correct resultant R of two vectors P and Q?

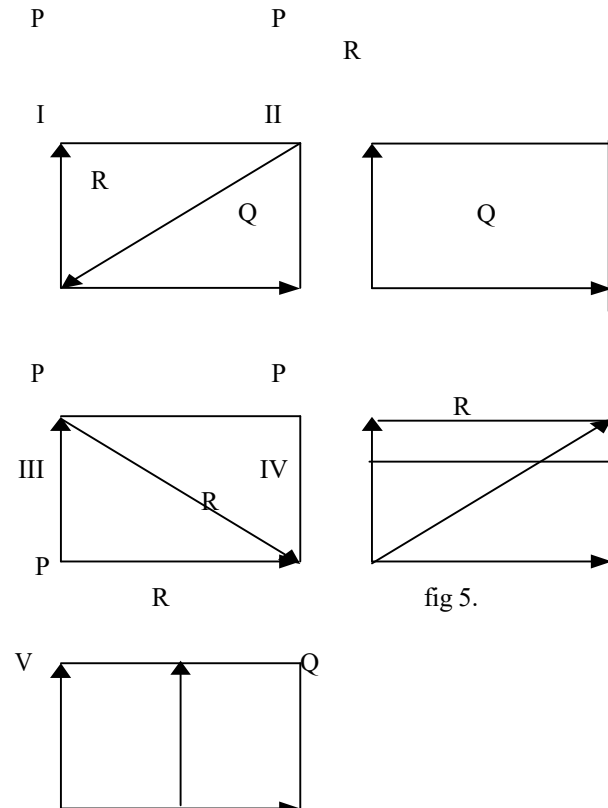

fig 5.

- A. I B. II
 C. III D. IV
 E. V

26. The electrochemical equivalent of a metal is 0.126×10^{-6} kg/C. The mass of the metal that a current of 5A deposit from a suitable bath in 1 hour is
 A. 0.0378×10^{-3} kg
 B. 0.227×10^{-3} kg
 C. 0.378×10^{-3} kg
 D. 0.595×10^{-3} kg
 E. 2.268×10^{-3} kg
27. Ripples on water are similar to light waves in that they both
 A. Have the same wavelength
 B. Are longitudinal
 C. Cannot be reflected
 D. Travel at the same speed
 E. Can be refracted and diffracted.
28. A piece of wood is floating on water. The forces acting on the wood are
 A. Upthrust and reaction.
 B. Weight and reaction
 C. Weight and upthrust
 D. Upthrust and viscosity
 E. Weight and viscosity.
29. Of the following derived units, the one that is not a unit of power is
 A. Joule/second
 B. Ampere/volt
 C. Amphere²volt
 D. Ohm²/volt
 E. Volts²/ohm.
30. A force of 16N applied to a 4.0kg block that is at rest on a smooth horizontal surface. What is the velocity of the block at $t = 5$ seconds?
 A. 4 m/s B. 10 m/s
 C. 20 m/s D. 50 m/s
 E. 80 m/s
31. 1,000 identical drops of oil of density 5000kg/m^3 have a total mass of 5×10^{-4} kg. One of the drops forms a thin film of area 0.5m^2 on water. The thickness of the film is
 A. $2 \times 10^{-8}\text{m}$ B. $2 \times 10^{-9}\text{m}$
 C. $2 \times 10^{-7}\text{m}$ D. $3 \times 10^{-9}\text{m}$
 E. $2.8 \times 10^{-8}\text{m}$.
32. The total length of a spring when a mass of 200g is hung from its end is 14cm, while its total length is 16cm when a mass of 30kg is hung from the same

end. Calculate the unstretched length of the spring assuming Hooke's law is obeyed.

- A. 9.33 cm B. 10.00cm
 C. 10.66cm D. 12.00cm
 E. 15.00cm

33. Each of the diagrams in Fig. 6 represents two current carrying conductors situated close to each other. In which two diagrams are the forces between the two wires attractive?

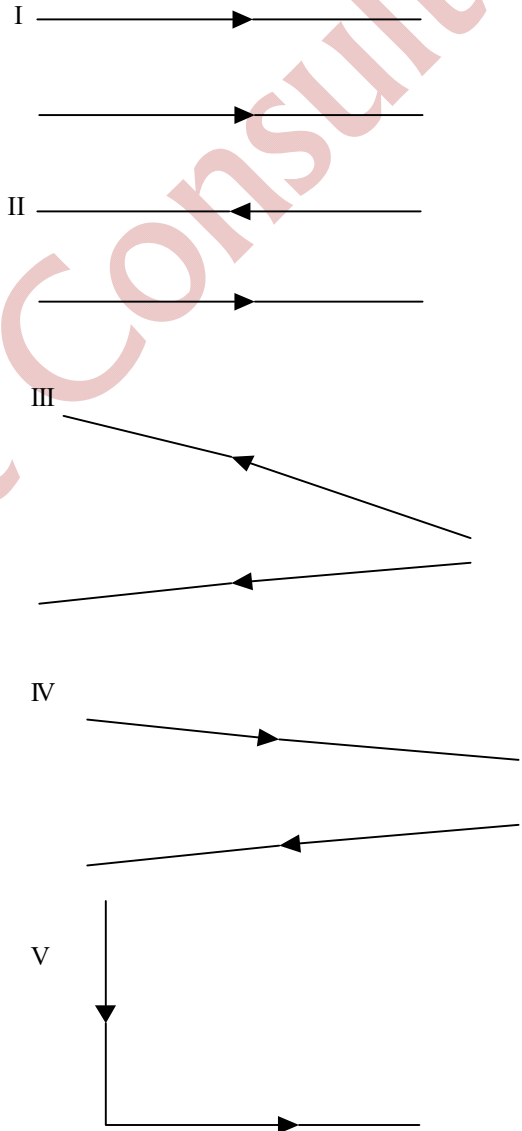

Fig .6

- A. I and V B. I and III
 C. II and IV D. II and V
 E. III and IV

34. Which of the following statements is CORRECT?
 I The mass number is equal to the total number of protons and electrons in an atom.
 II The atomic number is equal to the number of protons in an atom

- III The number of electrons in an atom is equal to the total number of protons and neutrons in the nucleus.
- A. I only B. II only
 C. III only D. I and II only
 E. II and III only.

35. A short response time is obtained in a liquid-in-glass thermometer when the
- A. Bulb is large and thick-walled.
 B. Stem is long and thin.
 C. Bulb is small and thick-walled.
 D. Bulb is high density and the bore is large.
 E. Bulb is thin-walled and the liquid is a good conductor of heat.

36. A machine has a velocity ratio of 5. It requires a 50kg weight to overcome a 200kg weight. The efficiency is
- A. 4% B. 5%
 C. 40% D. 50%
 E. 80%

37. If the normal atmospheric pressure in a laboratory supports a column of mercury 0.76m high and the relative density of mercury is 13.8, then the height of water column which atmospheric pressure will support in the same laboratory at the same time is
- A. 0m B. 10m
 C. 13m
 D. 14m
 E. 18m

38. An electric current of 3A flowing through an electric heating element of resistance 20 embedded in 1,000g of an oil raises the temperature of the oil by 10°C in 10 seconds, then the specific heat capacity of the oil is
- A. 1.8 J/g B. 0.6 J/g
 C. 0.18 J/g °C D. 1.8 J/g °C
 E. 0.06 J/g °C

39. The difference of potential between the terminals of a cell is 2.2 volts. When a 4 ohm resistor is connected across the terminals of this cell, the potential difference is 2 volts. What is the internal resistance of the cell?
- A. 0.10 ohms B. 0.25 ohms
 C. 0.40 ohms D. 2.50 ohms
 E. 4.00 ohms.

40. $\frac{Q}{I}$

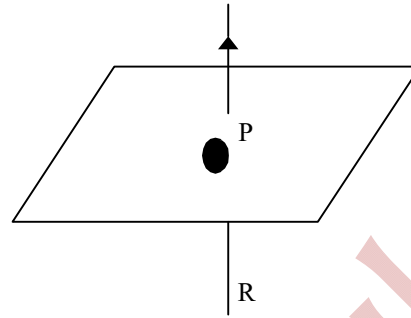

Fig. 7

In Fig. 7 above, QR is a vertical conductor and the current I flows from R to Q. P is a point on the horizontal plane and it is to the South of the wire. The direction of the magnetic field at P due to the current is

- A. Upward B. North
 C. South D. West
 E. East

41. Which of the following best describes the energy changes which take place when a steam engine drives a generator which lights a lamp?

- A. Heat → Light → Sound
 Kinetic
- B. Kinetic → Light → Heat
 → Electricity
- C. Heat → Kinetic → Electricity
 → Heat and Light
- D. Electricity → Kinetic → Heat
 → Light
- E. Heat → Sound → Kinetic
 → Electricity.

42. Which of the following statements clearly describe the behaviour of the fire alarm shown in Fig. 8 below given that the linear expansivities of copper and steel are $2.0 \times 10^{-5}/^{\circ}\text{C}$ and $1.2 \times 10^{-5}/^{\circ}\text{C}$ respectively?

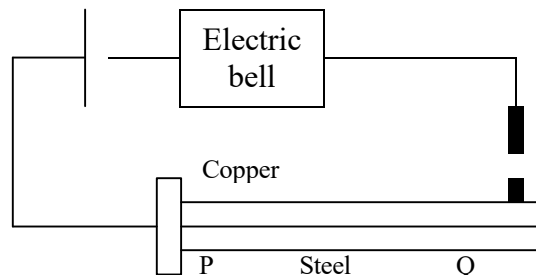

Fig. 8.

- I The bimetallic strip will not be able to close the circuit when there is fire
 II The bimetallic strip will close the circuit when there is fire
 III If the copper and steel are interchanged, the circuit will close when there is fire.
 A. I only B. II only
 C. III only D. I and III
 E. II and III
43. Four equal resistors R_1, R_2, R_3 and R_4 are connected in series as shown in Fig 9 below. V_1, V_2 and V_3 are voltmeters connected as indicated. Which of the following relations is **CORRECT**?
- A. $V_1 = V_3 = \frac{V_2}{2}$
 B. $V_1 = 2V_2 = V_3$
 C. $V_1 = \frac{1}{2} V_2 = \frac{1}{3} V_3$
 D. $V_1 - V_2 = V_3$
 E. $V_2 - V_1 = \frac{V_3}{2}$
44. Which of the following may be used to determine relative humidity in a physics laboratory?
- I Manometer
 II Wet-and-dry bulb hygrometer
 III Hair hygrometer
 IV A hydrometer
- A. I only
 B. II and III only
 C. II only
 D. III only
 E. II, III and IV only
45. The speed of light in vacuum is $3.0 \times 10^8 \text{ m s}^{-1}$. If the refractive index of a transparent liquid is $\frac{4}{3}$ then the speed of light in the liquid is
 A. $0.44 \times 10^8 \text{ m s}^{-1}$
 B. $2.25 \times 10^8 \text{ m s}^{-1}$
 C. $3.0 \times 10^8 \text{ m s}^{-1}$
 D. $4.0 \times 10^8 \text{ m s}^{-1}$
 E. $4.33 \times 10^8 \text{ m s}^{-1}$
46. If the force on a charge of 0.2 coulomb in an electric field is 4N, then the electric field intensity of the field is
 A. 0.8 B. 0.8 N/C
 C. 20.0 N/C D. 4.2 N/C
 E. 20.0 C/N
47. The specific latent heat of vapourization of a substance is always
 A. Less than its specific latent heat of fusion.
 B. Greater than its specific heat of fusion.
 C. Equal to its specific latent heat of fusion
 D. All of the above depending on the nature of the substance
 E. None of the above
48. Longitudinal waves do not exhibit
 A. Refraction B. Reflection
 C. Diffraction D. Polarization
 E. Rarefaction

45.

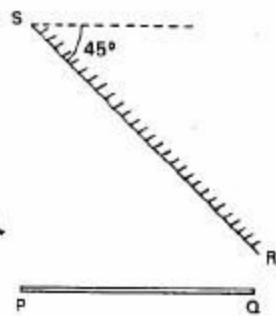

Fig. 10.

PQ is a thin rod on a horizontal table, RS is a plane mirror inclined at 45° to the horizontal as shown in Fig. 10 above. The image of PQ as seen in the mirror by the eye, T is

- A. Horizontal
 B. Parallel to the mirror
 C. At infinity
 D. Vertical

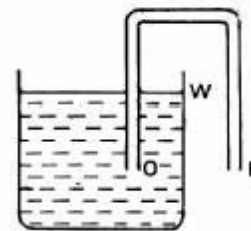

Fig. 11.

Fig. 11 above shows an inverted U-tube with the open end, O of one limb below the level, W, of the water in a tank. In order that water should begin to flow from the tank it is necessary that

- A. The U-tube is completely filled with water and P should be higher than W.
 B. P should be lower than O and W
 C. P should be lower than W and O should reach to the bottom of the vessel.
 D. The U-tube is completely filled with water and P should be lower than W.
 E. The U-tube is completely filled with water and O should reach the bottom of the vessel.

Physics 1984

1. The distance travelled by a particle starting from rest is plotted against the square of the time elapsed from the commencement of motion. The resulting graph is linear. The slope of this graph is a measure of
- Initial displacement
 - Initial velocity
 - Acceleration
 - Half the acceleration
 - Half the initial velocity

2.

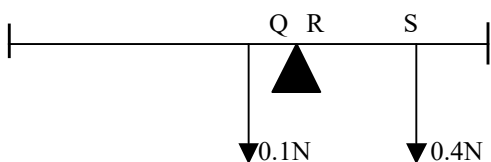

Fig. 1

In Fig. 1, PT is a uniform metre rule pivoted at R, the 70cm mark. Two forces 0.1N and 0.4N are applied at Q, the 60cm mark and S, the 85cm mark. If the metre rule is kept in equilibrium by the forces and its weight, then the weight of the metre rule is

- | | |
|----------|----------|
| A. 0.25N | B. 0.30N |
| C. 0.35N | D. 0.50N |
| E. 0.56N | |

3. For which of the underlisted quantities is the derived unit ML^2T^{-2} correct?

- Moment of a force
- Work
- Acceleration

- | | |
|---------------|-------------|
| A. I only | B. II only |
| C. III only | D. I and II |
| E. II and III | |

4. What volume of alcohol with a density of $8.4 \times 10^2 \text{ kg m}^{-3}$ will have the same mass as 4.2 m^3 of petrol whose density is $7.2 \times 10^2 \text{ kg m}^{-3}$?

- | | |
|----------------------|----------------------|
| A. 1.4 m^3 | B. 3.6 m^3 |
| C. 4.9 m^3 | D. 5.0 m^3 |
| E. 5.8 m^3 | |

5. For correcting long sight defects in the human eye we require a

- Converging lens
- Diverging lens
- Microscope
- Periscope
- Plain glass sheet.

6. For a concave mirror to form a real diminished image, the object must be placed
- Behind the mirror
 - Between the mirror and in focus
 - Between the focus and the center of curvature
 - At the center of curvature
 - At a distance greater than the radius of curvature.

7. The unit quantity of electricity is called

- The ampere
- The coulomb
- The ammeter
- Electromotive force.

8. The resistance of a wire depends on

- The length of the wire
- The diameter of the wire
- The temperature of the wire
- The resistivity of the wire
- All of the above.

9. What is the resistance of the circuit shown in Fig. 2.

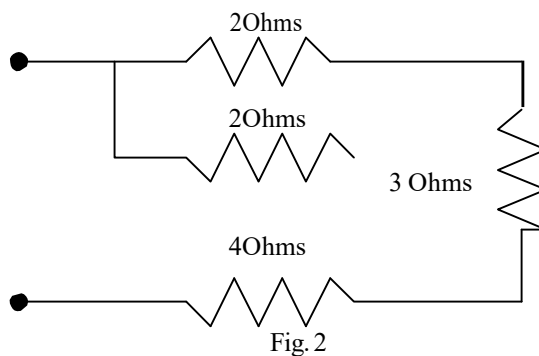

Fig. 2

- | | |
|------------------------|------------------------|
| A. 4 Ohms | B. 11 Ohms |
| C. $\frac{19}{5}$ Ohms | D. $\frac{17}{4}$ Ohms |
| E. 8 Ohms | |

10. Two cells, each of e.m.f. 1.5V and an internal resistance 2 Ohms are connected in parallel. Calculate the current flowing when the cells are connected to a 1 Ohms resistor.

- | | |
|--------------|-------------|
| A. 0.75 Ohms | B. 1.5 Ohms |
| C. 0.5 Ohms | D. 1.0 Ohms |
| E. 0.6 Ohms | |

11. Which of the following components is NOT contained in a dry cell? A

- A. Carbon rod
 B. Paste of magnesium dioxide
 C. Paste of ammonium chloride
 D. Zinc case
 E. Copper rod.
12. Which of the following can be described as high tension transmission?
 A. High resistance and low voltage
 B. Low current and high voltage
 C. High current and low voltage
 D. High voltage and zero current
 E. High current and low resistance.
13. All the heat generated in a 5 ohms resistor by 2A flowing for 30 seconds is used to evaporate 5g of liquid at its boiling point. Which of the following is the correct value of the specific latent heat of the liquid?
 A. 120 J B. 60 J g⁻¹
 C. 120 J g⁻¹ D. 1 500 J
 E. 1 500 J g⁻¹
14. When vibration occurs in an air column, the distance between a node and an antinodes is equal to
 A. One-quarter of the wavelength
 B. One-half of the wavelength
 C. The wavelength
 D. Twice the wavelength
 E. Four-times the wavelength.
15. Which of the following statements is (are) *NOT* correct?
 I Pressure changes do not affect the speed of sound in air
 II The velocity of sound increases with temperature
 III The quantity of a note depends only on its frequency.
 A. I only B. II only
 C. III only D. I and III only
 E. II and III only.
16. Of two identical tuning forks with natural frequency 256 Hz, one is loaded so that 4 beats per second are heard when they are sounded together. What is the frequency of the loaded tuning fork?
 A. 260Hz B. 252Hz
 C. 248Hz D. 264Hz
 E. 258Hz
17. Dew point is the temperature at which water vapour in the atmosphere
 A. Turns into steam
 B. Solidifies into ice pellets
 C. First condenses into liquid form
 D. Is just sufficient to cause cooling
 E. Has a relative of fifty percent.
18. The lower and upper fixed points marked on a mercury-in-glass thermometer are 210mm apart. The end of the mercury column in the tube is 49mm above the lower fixed point in a room. What is the temperature of the room in degrees Celsius?
 A. 55.3 °C B. 23.3 °C
 C. 49.0 °C D. 16.1 °C
 E. 76.7 °C
19. If a solid changes directly into a gas when heat is applied the process is called
 A. Vaporization
 B. Evaporation
 C. Sublimation
 D. Ionization
 E. Conversion.
20. A plane inclined at an angle of 30° to the horizontal has an efficiency of 60%. The force parallel to the plane required to push a load of 120N uniformly up the plane is
 A. 60 N B. 100N
 C. 120N D. 200N
 E. 240N
21. A body of mass 5kg initially at rest is acted upon by two mutually perpendicular forces 12N and 5N as shown in Fig. 3. If the particle moves in the direction QA, calculate the magnitude of the acceleration.
 A. 0.40m s⁻² B. 1.40m s⁻²
 C. 0.26m s⁻² D. 2.60m s⁻²
 E. 3.40m s⁻²

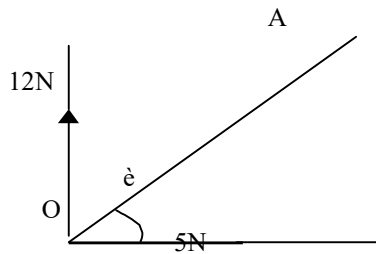

Fig. 3

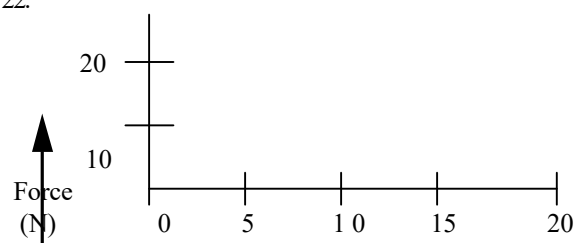

Fig. 4

body by the force during the first 10 metres of motion is

- A. 100J B. 150J
C. 200J D. 300J
E. 600J

23. A simple pendulum, 0.6m long, has a period of 1.5 s. what is the period of a similar pendulum 0.4m long in the same location?

- A. $1.4\sqrt{2/3}$ s B. $1.5\sqrt{2/3}$ s
C. 2.25 s D. 1.00 s
E. 2.00 s

A force varying linearly with the distance acts on a body as shown in Fig. 4. The work done on the body by the force during the first 10 metres of motion is

- A. 100J B. 150J
C. 200J D. 300J
E. 600J

23. A simple pendulum, 0.6m long, has a period of 1.5 s. what is the period of a similar pendulum 0.4m long in the same location?

- A. $1.4\sqrt{2/3}$ s B. $1.5\sqrt{2/3}$ s
C. 2.25 s D. 1.00 s

24. A small steel needle is carefully floated on water in a beaker. When a few drops of kerosene are introduced into the water the needle sinks. Which of the following statements correctly explain(s) the observation?

- I There is a tension on the water surface.
II Kerosene reduces the density of water so that the needle becomes denser than water.
III Kerosene reduces the surface tension of water.

- A. I only B. II only
C. III only D. I and II
E. I and III

25. Which of the following statements describes an atom accurately?

- I Atoms of all elements are identical
II An atom contains a nucleus and number of electrons.
III Due to the electrons in the atom, an atom is negatively charged.
IV Electrons in the atom move in circular orbits round the nucleus.

- A. I and II B. II and III
C. III and IV D. II and IV
E. I, II and III

26. A particle moves in a circular orbit of radius 0.02m. If the speed of the particle is $0.8\pi\text{m s}^{-1}$, calculate its frequency in cycles per second.

- A. 2.0 B. 7.0
C. 8.8 D. 14.0
E. 17.6

27. Heat is supplied uniformly at the rate of 100W to $1.0 \times 10^{-3}\text{kg}$ of a liquid for 20 seconds. If the temperature of the liquid rises by 5°C , then the specific heat capacity of the liquid is

- A. $2.0 \times 10^2\text{J kg}^{-1}\text{K}^{-1}$
B. $2.0 \times 10^3\text{J kg}^{-1}\text{K}^{-1}$
C. $4.0 \times 10^4\text{J kg}^{-1}\text{K}^{-1}$
D. $4.0 \times 10^4\text{J kg}^{-1}\text{K}^{-1}$
E. $8.4 \times 10^3\text{J kg}^{-1}\text{K}^{-1}$

28. A given mass of an ideal gas occupies a volume V at a temperature T and under a pressure P. If the pressure is increase to 2P and the temperature reduced to $1/2T$, then the percentage change in the volume of the gas is

- A. 0 % B. 25 %
C. 75 % D. 300 %
E. 400 %

29. Which of the following properties of matter CANNOT be utilized for temperature measurement? The

- A. Length of a liquid column
B. Volume of a gas at constant pressure.
C. Pressure of a gas at constant volume
D. Resistance of a metallic wire
E. Current produced in a photoelectric effect.

30. The image and object distances of a converging mirror are related by the equation $1/f = 1/v + 1/u$ and the magnification of the image is $m = v/u$. Which of the graphs below represents the relation between m and v?

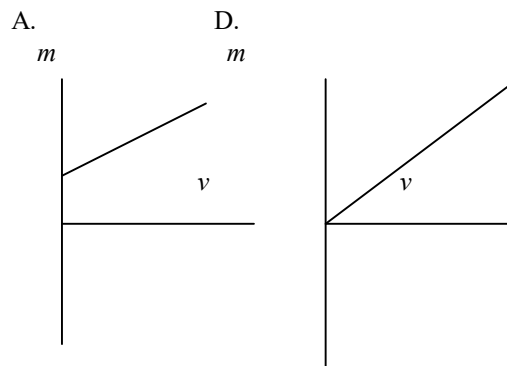

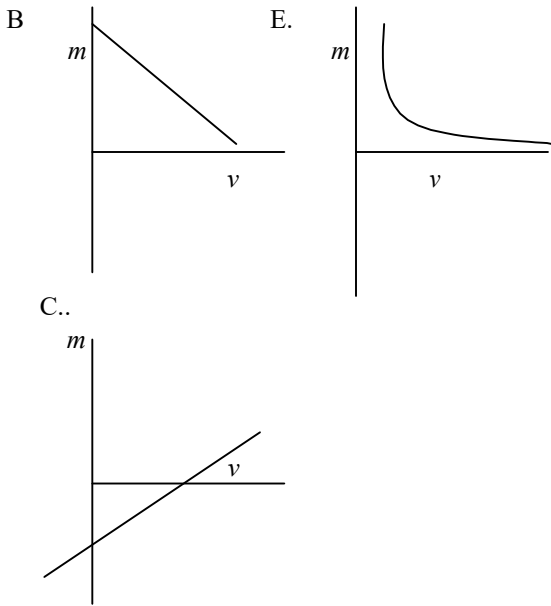

31. Which of the following statements about the compound microscope and astronomical telescope is (are) correct?

- I The final image of a compound microscope is located at infinity.
- II The final image of the astronomical telescope is always erect.
- III The objective lens of a compound microscope has a very short focal length.

- A. I only
- B. II only
- C. III only
- D. I and III
- E. II and III

32. A coin is placed at the bottom of a cube of glass t cm thick. If the refraction index of the glass is σ , how high does the coin appear to be raised to an observer looking perpendicularly into the glass?

- A. $\frac{t}{\sigma - 1}$
- B. $\frac{t(\sigma - 1)}{\sigma}$
- C. $t > \frac{1}{\sigma} + \frac{1}{\sigma^2}$
- D. $\frac{t}{\sigma}$
- E. t

33. The electromotive force obtained from a simple dynamo may be increased by

- A. Increasing the cross-sectional area of the coil.
- B. Winding the coil on a soft-iron armature so as to increase the magnetic flux through the coil.

- C. Increasing the speed of rotation.
- D. Making the field magnet longer.
- E. Using low resistance copper coil.

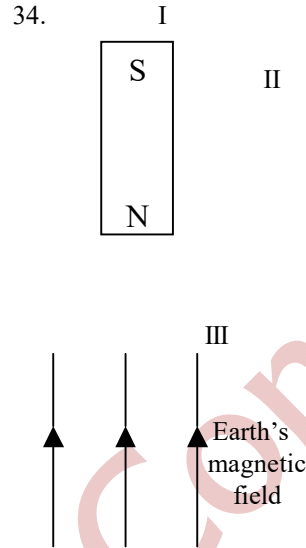

Fig. 5

A short bar magnet is placed in the earth's magnetic field as shown in Fig. 5. Which of the points II and III is (are) possible position(s) of a natural point?

- A. I only
- B. II only
- C. III only
- D. I and II
- E. I, II and III

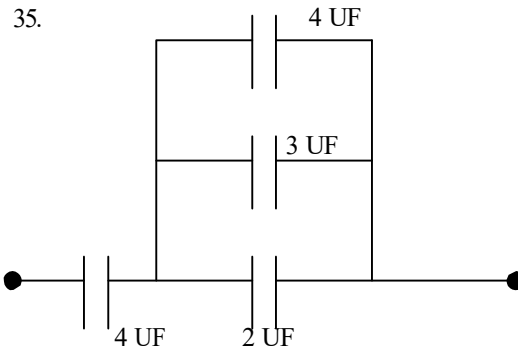

Fig. 6

In the circuit in Fig. 6, calculate the effective capacitance between X and Y.

- A. $\frac{3}{4}$ UF
- B. $2 \frac{10}{13}$ UF
- C. 12 UF
- D. $4 \frac{12}{13}$ UF
- E. 13 UF

36. A gun of mass 2.0 kg fires a bullet of mass 1.6×10^{-2} kg due East. If the bullet leaves the nozzle of the gun

- with a velocity of 150 m s^{-1} , what is the recoil velocity of the gun?
- 150 m s^{-1} due West
 - $1.2 \times 10^{-4}\text{ m s}^{-1}$ due West.
 - 1.2 m s^{-1} due West
 - 1.2 m s^{-1} due East
 - 150 m s^{-1} due East
37. Normal atmospheric pressure at sea-level is 10^5 N m^{-2} and the acceleration due to gravity is approximately 10 m s^{-1} . If the atmosphere has a uniform density of 1 kg m^{-3} , its height is
- 100 m
 - 1000 m
 - 10 000 m
 - 100 000 m
 - 1000000 m
38. Which of the following is a correct explanation of the inertia of a body?
- Ability to overcome the earth's gravity
 - Reluctance to stop moving
 - Readiness to start moving
 - Reluctance to start moving and its readiness to stop moving once it has begun to move
 - Reluctance to start moving and its reluctance to stop moving once it has begun to move.
39. If a water pump at Kainji Dam is capable of lifting 1000kg of water through a vertical height of 10m in 10s, the power of the pump is
- | | |
|-----------|-----------|
| A. 1.0kW | B. 10.0kW |
| C. 12.5kW | D. 15.0kW |
| E. 20.0kW | |
- ($g = 10\text{ m s}^{-2}$)
40. What is the apparent colour of a RED SHIRT when viewed in PURE green light?
- | | |
|-----------|----------|
| A. Red | B. Green |
| C. Yellow | D. Black |
| E. Blue | |
41. The spectrum of white light consists of coloured lights arranged in the following order
- Blue, red, green. Yellow, indigo, violet, orange.
 - Red, orange, yellow, green, blue, indigo, violet.
 - Red, orange, yellow, indigo, green, blue, violet.
 - Indigo, green, blue, violet, yellow, red, orange.
 - Yellow, blue, green, violet, orange, indigo, red.
42. Cathode rays are
- High-energy electromagnetic waves
 - Protons
 - Streams of electrons
 - Neutrons
 - Radio waves
43. A device that converts sound energy into electrical energy is
- The horn of a motor car
 - An A.C. generator
 - A microphone
 - The telephone earpiece
 - A loudspeaker.
44. Which of the following
I α -particles
II Protons
III Neutrons
IV β -particles
may be found in light nuclei?
- I and II
 - I and III
 - II and IV
 - II and III
 - I, II, and III.
45. Radio waves have a velocity of $3 \times 10^8\text{ m s}^{-1}$. A radio station sends out a broadcast on a frequency of 800 kHz. The wavelength of the broadcast is
- 375.0m
 - 267.0m
 - 240.0m
 - 37.5 m
 - 26.7 m
- 46.

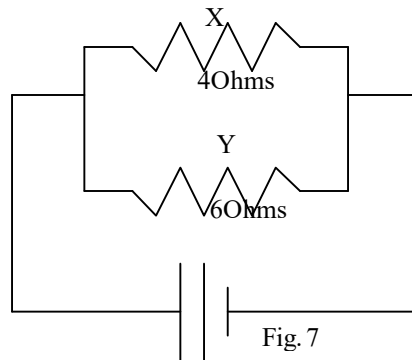

Fig. 7

In the diagram above (Fig. 7), X and Y are resistances 45 ohms and 65 ohms respectively. If power dissipation in X is 10W, then power dissipation in Y is

- | | |
|-----------|----------|
| A. 2.4 W | B. 4.0 W |
| C. 6.0 W | D. 6.7 W |
| E. 15.0 W | |

47. What is the cost of running five 50W lamps and four 100W lamps for 10 hours if electrical energy costs 2 kobo per kWh?

- A. ₦0.65 B. ₦0.13
 C. ₦3.90 D. ₦39.00
 E. ₦234.00

48. Which of the following statements is (are) *NOT* true about the emission of photoelectrons from metallic surfaces?

- I All metallic surfaces emit the same number of photoelectrons in a given light.
 II Most metallic surfaces in visible and infrared light.
 III A metallic surface emits photoelectric only if frequency of the incident light is higher than its own characteristic threshold frequency.

- A. I only B. II only
 C. I and II D. II and III
 E. III only

49. A galvanometer of resistance 5.0Ω has full-scale deflection for a current of 100mA. How would its range be extended to 1.0A by placing a resistance of

- A. $\frac{5}{9}$ Ohms in parallel
 B. $\frac{9}{5}$ Ohms in series
 C. 45 Ohms in parallel
 D. 45 Ohms in series
 E. $\frac{9}{5}$ Ohms in parallel.

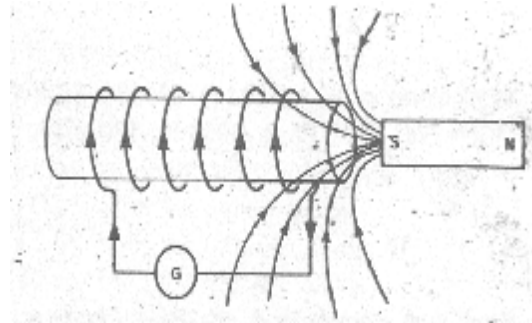

50. Fig 8 above represents an insulated cylindrical coil or copper wire wound round a paper tube. The ends of the coil are connected to a sensitive galvanometer. When a magnet was plunged into the coil it was observed that the galvanometer needle gave a deflection. Which of the following correctly describes this experiment?

- A. The effect illustrated is induced electromotive force.
 B. The strength of the current produced is inversely proportional to the speed with which the magnet is plunged into the coil.
 C. The direction of the current is always such as to enhance the change producing it.
 D. The galvanometer gave a permanent deflection.
 E. On removing the magnet from the coil the galvanometer deflected in the same direction.

Physics 1985

1. Which of the following is *NOT* a fundamental S.I. unit?

- A. Metre B. Ampere
 C. Kelvin D. Second
 E. Radian

2. A simple pendulum with a period of 2.0s has its length doubled. Its new period is

- A. 1.00 s B. 1.41 s
 C. 0.35 s D. 2.83 s
 E. 4.00 s

3. Which of the following statements are true about the spring balance and the chemical balance?

- I Both are used to measure the mass of an object.
 II Either of them may be used to measure the weight of an object.
 III The spring balance works on the principle of Hooke's law while the chemical balance works on the principle of moments.
 IV A change in gravity changes the readings of a spring balance but not that of a chemical balance.
- A. I and IV B. II and III
 C. III and IV D. I, II, and III
 E. I and III.

4. Which of the following types of motion are oscillatory?
- I A driving board when used by a driver.
 - II The motion of the balance wheel of a wrist watch.
 - III The motion of the turn-table of a record player.
 - IV The motion of the center of a ten kobo piece as it rolls down an inclined plane.
 - V The motion of the needle of a D.C. ammeter into which a low A.C. current is passed.
- A. I and II only B. I, II and III
 C. II, III and IV D. I, II and V
 E. III, IV, and V.

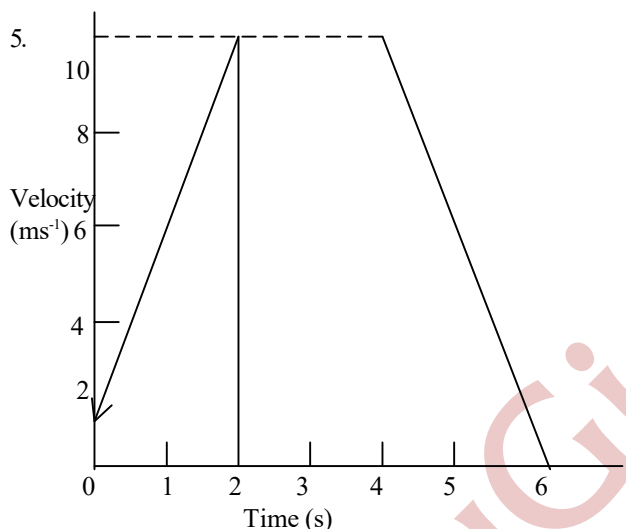

Fig 1

The graph Fig. 1 above describes the motion of a particle. The acceleration of the particle during the motion is

- A. 0.00m s^{-2} B. 0.25m s^{-2}
 C. 4.00m s^{-2} D. 8.00m s^{-2}
 E. 10.00m s^{-2}
6. If a car starts from rest and moves with a uniform acceleration of 10m s^{-2} for ten seconds, the distance it covers in the last one second of the motion is
- A. 95 m B. 100 m
 C. 500 m D. 905 m
 E. 1000m
7. A block of mass 2.0kg resting on a smooth horizontal plane is acted upon simultaneously by two-forces, 10N due North and 10N due East. The magnitude of the acceleration produced by the forces on the block is
- A. 0.10m s^{-2} B. 7.05m s^{-2}
 C. 10.00m s^{-2} D. 14.10m s^{-2}
 E. 20.00m s^{-2}

8. A metal block of mass 5kg lies on a rough horizontal platform. If a horizontal force of 8N applied to the block through its centre of mass just slides the block on the platform, then the coefficient of limiting friction between the block and the platform is
- A. 0.16 B. 0.63
 C. 0.80 D. 1.60
 E. 2.00

9. Which of the following is *NOT* a force?
- A. Friction
 B. Tension
 C. Upthrust
 D. Weight
 E. Impulse.
10. Two masses 40g and 60g respectively, are attached firmly to the ends of a light metre rule. The centre of gravity of the system is
- A. At the mid-point of the metre rule
 B. 40cm from the lighter mass
 C. 40cm from the heavier mass
 D. 60cm from the heavier mass
 E. indeterminate because the metre-rule is light.

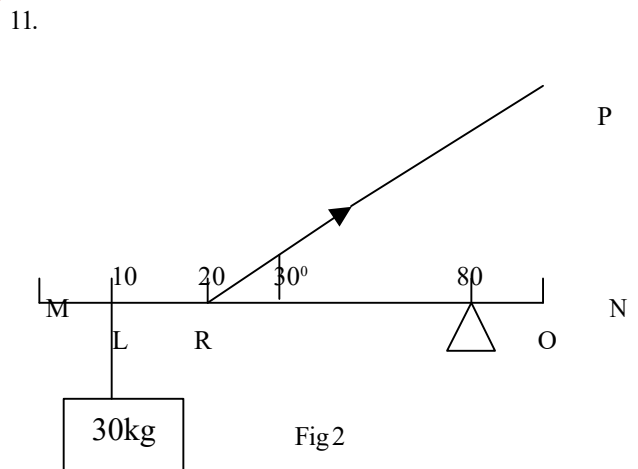

Fig 2

In Fig. 2 above. MN is a light uniform metre rule pivoted at O, the 80cm mark. A load of mass 3.0kg is suspended on the rule at L, the 10cm mark. If the rule is kept in equilibrium by a string RP, fixed at P and attached to the rule at R, the 20cm mark, then the tension T in the string is

- A. 25 N B. 50 N
 C. 250 N D. 5 000 N
 E. 25 000 N
12. A 0.05kg bullet traveling at 500m s^{-1} horizontal strikes a thick vertical wall. A load of mass 3.0kg is

- suspended on the rule at L, the 10cm mark. If the rule is kept in equilibrium by a string RP, fixed at P and attached to the rule at R, the 20cm mark, then tension T in the string is
- A. 25 N B. 50 N
C. 250 N D. 5 000 N
E. 25 000 N
13. A force of 100N stretches an elastic string to a total length of 20cm. If an additional force of 100N stretches the string 5cm further, find the natural length of the string.
- A. 15 cm B. 12 cm
C. 10 cm D. 8 cm
E. 5 cm
14. Two divers G and H are at depths 20m and 40m respectively below the water surface in a lake. The pressure on G is P_1 while the pressure on H is P_2 . If the atmospheric pressure is equivalent to 10m of water, then the value of P_2/P_1 is
- A. 0.50 B. 0.60
C. 1.67 D. 2.00
E. 3.00
15. The areas of the effort and load pistons of a hydraulic press are 0.5m^2 and 5m^2 respectively. If a force F_1 of 100N is applied on the effort piston, the force F_2 on the load is
- A. 10 N B. 100 N
C. 500 N D. 1 000 N
E. 5 000 N
16. A metal cube of volume 10^3mm^3 is lowered into a measuring cylinder containing water. If the internal cross-sectional area of the cylinder is $1.5 \times 10^2\text{mm}^2$, by how much does the water level rise in the cylinder?
- A. $6.67 \times 10^0\text{mm}$ B. $8.50 \times 10^2\text{mm}$
C. $1.15 \times 10^3\text{mm}$ D. $2.50 \times 10^3\text{mm}$
E. $1.50 \times 10^3\text{mm}$
17. A uniform cylindrical block of wood floats in water with one-third of its height above the water level. In a liquid of relative density 0.8, What fraction of its height will be above the liquid level?
- A. $\frac{1}{6}$ B. $\frac{1}{5}$
C. $\frac{1}{6}$ D. $\frac{4}{5}$
E. $\frac{5}{6}$
18. A thin aluminum plate has a surface area of $1,500\text{m}^2$ at 20°C . What will be its surface area when it is cooled to -20°C ? (Take the linear expansivity of aluminium to be $2.5 \times 10^{-5}\text{K}^{-1}$)
- A. 1.503m^2 B. 1.500m^2
C. 1.498m^2 D. 1.497m^2
E. 1.490m^2
19. Two liquids, P at a temperature of 20°C and Q at a temperature of 80°C have specific heat capacities of $1.0\text{J kg}^{-1}\text{ }^\circ\text{C}^{-1}$ and $1.5\text{J kg}^{-1}\text{ }^\circ\text{C}^{-1}$ respectively. If equal masses of P and Q are mixed in a lagged calorimeter, then the equilibrium temperature is
- A. 44°C B. 50°C
C. 56°C D. 60°C
E. 70°C
20. A quantity of gas occupies a certain volume when the temperature is -73°C and the pressure is 1.5 atmospheres. If the pressure is increased to 4.5 atmospheres and the volume is halved at the same time, what will be the new temperature of the gas?
- A. 573°C B. 327°C
C. 300°C D. 110°C
E. 27°C
21. In a gas experiment, the pressure of the gas is plotted against the reciprocal of the volume of the gas at a constant temperature. The unit of the slope of the resulting curve is
- A. Force B. Force/m
C. Work D. Force/ m^3
E. Energy/ m^2 .
22. Water shows anomalous behaviour
- A. Below 0°C
B. Between 0°C and 4°C
C. At exactly 4°C
D. Between 4°C and 100°C
E. Above 100°C
23. Two thermos flasks of volume V_x and V_y are filled with liquid water at an initial temperature of 0°C . After some time the temperatures were found to be θ_x , θ_y respectively. given that
- $$\frac{V_x}{V_y} = 2 \text{ and } \frac{\theta_x}{\theta_y} = \frac{1}{2}$$
- The ratio of the heat flow into the flasks is
- A. $\frac{1}{4}$ B. $\frac{1}{2}$
C. 4 D. 1
E. 2
24. A good calorimeter should be of
- A. Low specific heat capacity and low heat conductivity.
B. Low specific heat capacity and high heat conductivity.
C. High specific heat capacity and low heat conductivity
D. High specific heat capacity and low heat conductivity,
E. Dull surface and low heat conductivity.

25. Which of the following statements is *NOT* correct?
- Boiling occurs when the saturated vapour pressure of the liquid involved equals the external pressure.
 - Both the boiling point and the saturated vapour pressure of a given liquid depend on the external pressure.
 - The saturated vapour pressure rises with increase in temperature.
 - The saturated vapour pressure is independent of the volume available for the vapour.
 - It is possible to boil water at a lower temperature than 100°C at high altitude.
26. Which of the following phenomena *CANNOT* be explained by the molecular theory of matter?
- Expansion
 - Conduction
 - Convection
 - Radiation
 - Evaporation.
27. In order to find the depth of the sea. A ship sends out a sound wave and receives an echo after one second. If the velocity of sound in water is 1500m/s , what is the depth of the sea?
- 0.75km
 - 1.50km
 - 2.20km
 - 3.00km
 - 3.75km
28. When a sound wave passes from air into water its
- Speed and frequency increase but its wavelength remains the same.
 - Speed and wavelength increase but its frequency remains the same
 - Speed decreases.
 - Speed remains the same but its frequency and wavelength change.
 - Speed increases but its frequency and wavelength decrease.
29. If the fundamental frequency of a closed pipe organ on a day when the speed of sound is 340m s^{-1} is 170 Hz , then the length of the pipe is
- 50cm
 - 70cm
 - 100cm
 - 150cm
 - 200cm
30. An object is placed 15cm in front of a concave mirror of radius 40cm . The image formed is
- Virtual and 60cm behind the mirror
 - Real and 60cm in front of the mirror
 - Virtual and at infinity
 - Real and at infinity
 - Virtual and 40cm from the mirror.
31. A 45° triangular glass prism can be used as a reflector of light because
- Refraction never takes place in such a prism
 - The angle of reflection equals the angle of incidence.
 - The refractive index of glass is less than 1
 - It is transparent
 - The critical angle for glass is less than 45°
32. A convex mirror is used as a driving mirror because
- Its image is erect
 - It has a large field of view
 - It has a long focal length
- Identify the *CORRECT* statement(s).
- I and III only
 - I and II only
 - II and III only
 - I, II and III only
 - I only
33. Two rays of light from a point below the surface of water are equally inclined to the vertical and are inclined to each other at 60° in water. What is the angle between the rays when they emerge into air? (Take the refractive index of water to be $4/3$)
- 41.8°
 - 44.1°
 - 60.0°
 - 83.6°
 - 120.0°
34. A narrow beam of white light can be split up into different colours by a glass prism. The correct explanation is that
- White light is an electromagnetic wave
 - The prism has all the colours of the white light
 - White light has undergone total internal reflection in the prism
 - Different colours of white light travel with different speeds in glass.
 - White light consists of yellow, green and red colours.
35. A charge of one coulomb liberates 0.0033g of copper in an electrolytic process. How long will it take a current of 2A to liberate 1.98g of copper in such a process.
- 5 minutes
 - 30 minutes
 - 50 minutes
 - 60 minutes
 - 120 minutes
36. If the distance between two stationary charged particles is doubled, the magnitude of the electrostatic force between them will be

- A. Passing on an electric current through a solenoid.
- B. Repeated stroking of the specimen with a magnet
- C. Repeated stroking of the specimen in opposite directions with two magnets
- D. Heating of the specimen
- E. Hammering of the specimen in the earth's magnetic field's

39. Which of the following will convert a milliammeter to a voltmeter?
- A. Low series resistance
 - B. Low parallel resistance
 - C. High series resistance
 - D. High parallel resistance
 - E. Parallel resistance equal to milliammeter resistance.

40. Which of the graphs A – E (Fig. 3) represents the current-voltage (I – V) relationship for a cell with internal resistance?

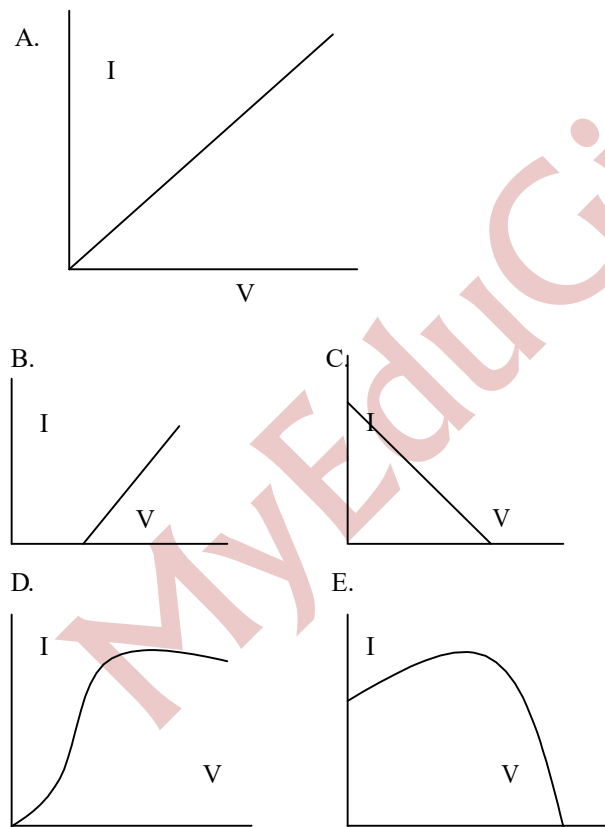

Fig. 3

41. A wire *P* has half the diameter and half the length of a wire *Q* of similar material. The ratio of the resistance of *P* to that of *Q* is
- A. 8 : 1
 - B. 4 : 1
 - C. 2 : 1
 - D. 1 : 1
 - E. 1 : 4

42. An electric kettle, connected to a 240V mains, produces 6.0×10^5 J of heat energy to boil a quantity of water in 5 minutes. Find the resistance of the kettle.
- A. 14.4 ohms
 - B. 28.8 ohms
 - C. 144 ohms
 - D. 288 ohms
 - E. 2 880 ohms

43. On which of the following does the operation of a moving coil ammeter depend?
- I Electromagnetic induction.
 - II Force on a current-carrying conductor in a magnetic field.
 - III Magnetic effect of an electric current.
- A. I only
 - B. II only
 - C. III only
 - D. II and III
 - E. I, II and III

- 44.

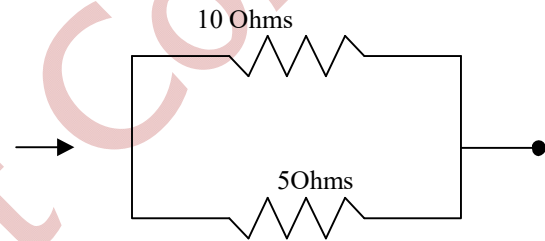

Fig. 4

In Fig. 4, current (*I*) passes through the parallel combination. If the power dissipated in the 5 ohms resistor is 40W, then the power dissipated in the 10 ohms resistor is

- A. 10 W
- B. 20 W
- C. 40 W
- D. 80 W
- E. 100 W

45. Which of the following statements is *NOT* correct?
- A. A galvanometer can be converted to an ammeter with a different range by connecting a high resistance in series.
 - B. An electric current always produces a magnetic field
 - C. Maxwell's screw rule states that if a corkscrew moves in the direction of the current, the hand turns in the direction of the lines of force.
 - D. Electromagnets are used in electric bells and telephone receivers.
 - E. The lines of force round a straight current carrying conductor are circular.

46. A transformer has a primary coil with 500 turns and secondary coil with 2500 turns. When the voltage input to the primary coil is 120V, the output is

- A. 6000 V B. 600 V
 C. 240 V D. 60 V
 E. 24 V
47. Which of the following statements about electrolysis is *NOT* correct?
 A. The substances in solution in the electrolyte become ionized.
 B. Ions are electrically charged and are attracted towards electrodes when a potential difference is applied.
 C. Ions may be discharged at the electrodes, forming bubbles or deposits.
 D. The mass deposited depends upon the length of time for which current flows.
 E. The mass of gas set free or metal deposited is proportional to the square of the current.
48. Which of the following statements is *NOT* correct?
 A. The average range of distinct vision for a normal eye is from the far distance (infinity) up to about 25cm in front of the eye.
 B. Longsighted people have difficulty in making the eye lens sufficiently powerful to the focus on nearby objects.
- C. Shortsighted people cannot accommodate distant objects.
 D. Longsighted people need diverging spectacles lenses.
 E. A person with long sight has his eye-ball too short and the image of an object is therefore formed behind the retina.
49. Which of the following features is *NOT* a characteristic of natural radioactivity?
 A. Radioactivity is a nuclear phenomenon.
 B. Radioactivity is exhibited only by elements of mass number greater 206.
 C. The radioactivity of an element is affected by electric and magnetic fields in the surroundings.
 D. The radioactive element is transformed into a new element.
50. What is the number of neutrons in the Uranium isotope ${}^{238}_{92}\text{X}$?
 A. 92
 B. 146
 C. 238
 D. 330
 E. 119

Physics 1986

1. Which of the following represents the correct precision if the length of a piece of wire is measured with a metre rule?
 A. 35 mm
 B. 35.0 mm
 C. 35.00 mm
 D. 35.01 mm

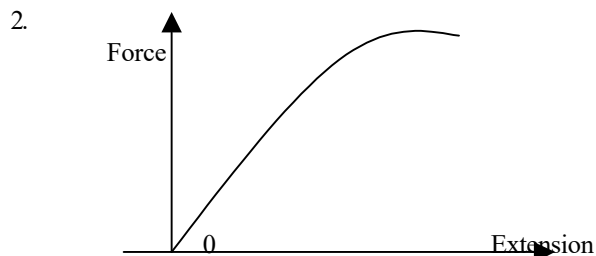

Figure 1 is a graph of force against extension for a spiral spring. The force constant of the spring is given by the.

- A. Slope of the linear portion of the graph.
 B. Length of the linear portion of the graph.
 C. Area under the linear portion of the graph.
 D. Area under the entire graph.
3. A heavy object is suspended from a string and lowered into water so that it is completely submerged. The object appears lighter because
- A. The density of water is less than that of the object.
 B. The pressure is low just below the water surface.
 C. It experiences an upthrust.
 D. The tension in the string neutralizes part of the weight.

4. Which of the following is a derived unit?
 A. Kilogramme B. Metre
 C. Kelvin D. Newton
5. Two objects, one having three times the mass of the other, are dropped at the same time from a tall building. When they are above the ground, the two objects will have the same
 A. Momentum
 B. Kinetic energy
 C. Potential energy
 D. Acceleration.
6. Which of the following is in a neutral equilibrium?
 A. A heavy weight suspended on a string.
 B. A cone resting on its slant edge.
 C. A heavy based table lamp.
 D. The beam of a balance in use.
7. A ball is thrown vertically into the air with an initial velocity u . What is the greatest height reached?
 A. $\frac{u}{2g}$
 B. $\frac{3u^2}{2g}$
 C. $\frac{u^2}{g}$
 D. $\frac{u^2}{2g}$.

8. Which of the following assumptions is made in a simple pendulum experiment? The
 A. Suspending string is inextensible
 B. Bob has a finite size
 C. Bob has a definite mass
 D. Initial angle of oscillation must be large.

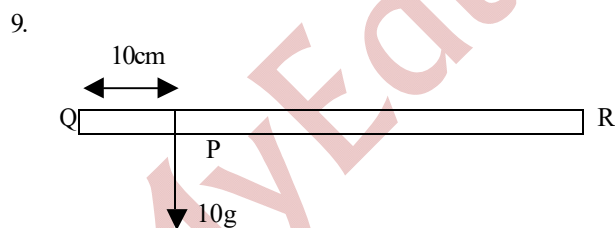

Fig. 2

A uniform metre rule QR is balanced on a knife edge which is 55cm from R. when a mass of 10g is hung at P as shown in Fig. 2, the mass of the metre rule is

- A. 550g B. 350g
 C. 70g D. 35g
- 10.
-
- The diagram shows a point O. A horizontal force vector F_2 points to the right and is labeled '5.0N'. Another force vector F_1 points upwards and to the right, making a 60° angle with F_2 . It is labeled '10.0N'. A third force vector F_3 points upwards and to the left.

Fig. 3

- In Fig. 3, the forces F_1 , F_2 , F_3 acting at O are in equilibrium. If the magnitude of F_1 is 10.0N and the magnitude of F_2 is 5.0N, find the magnitude of F_3 .
- A. 26.4N B. 15.0N
 C. 13.2N D. 10.0N

11. When a box of mass 400g is given an initial speed of 5m s^{-1} , it slides along a horizontal floor a distance of 3m before coming to rest. What is the coefficient of the kinetic friction between the box and the floor?
 ($g = 10\text{m s}^{-2}$)
 A. $\frac{5}{6}$ B. $\frac{5}{12}$
 C. $\frac{1}{3}$ D. $\frac{2}{3}$

12.

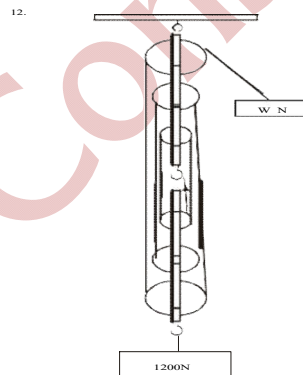

- Figure 4 represents a block-and-tackle pulley system on which an effort of W Newtons supports a load of 120.0N. If the efficiency of the machine is 40° , then the value of W is
 A. 28.0N B. 48.0N
 C. 50.0N D. 288.0N

13. A constant force of magnitude F acts on an object of mass 0.04kg initially at rest at a point O. If the speed of the object when it has moved 50m from O is 500m s^{-1} , what is the value of F ?
 A. 0.4 N B. 100.0N
 C. 250.0 N D. 1000.0N
14. A rectangular tank contains water to a depth of 2m. if the base is 4m x 3m, calculate the force on the base.
 (Density of water = 10^3kg m^{-3} , $g = 10\text{m s}^{-2}$)
 A. $2.4 \times 10^5\text{N}$ B. $2.4 \times 10^4\text{N}$
 C. $2.0 \times 10^4\text{N}$ D. $1.7 \times 10^3\text{N}$

15. A 1000kg elevator is descending vertically with an acceleration of 1.0ms^{-2} , if the acceleration due to gravity is 10.0m s^{-2} , the tension in the suspending cable is
 A. 1.0 N B. 10.0 N
 C. 9 000.0 N D. 11 000.0 N

16. A ball attached to one end of a string moves anticlockwise around a circle whose centre is O. If the string suddenly breaks when the ball is at point P, along which of the following paths will it move?

F₃

16.

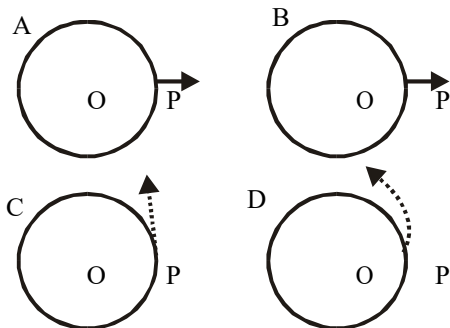

17. The mode of heat transfer which does not require material medium is
- | | |
|---------------|----------------|
| A. Conduction | B. Radiation |
| C. Convection | D. Propagation |
18. The expansion of solids can be considered a disadvantages in the
- | |
|------------------------------|
| A. Balance wheel of a watch |
| B. Fitting of wheels on rims |
| C. Fire alarm |
| D. Thermostat. |

19.

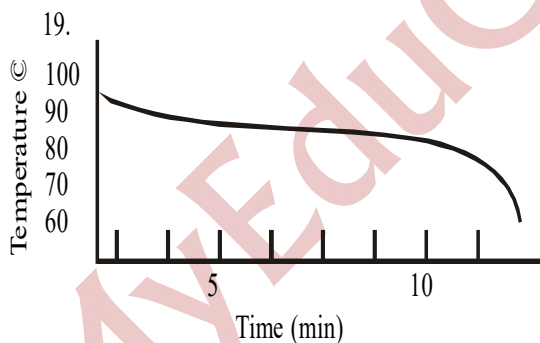

Fig.5

In an experiment in which molten naphthalene is allowed to cool. The cooling curve in Fig. 5 was obtained. The temperature 80°C is known as the

- | |
|------------------------|
| A. Cooling temperature |
| B. Boiling point |
| C. Melting point |
| D. Vaporization point |
20. The specific latent heat of fusion of lead is the amount of heat required to
- | |
|--|
| A. Melt lead at its melting point |
| B. Heat a unit mass of lead through 1°C. |

- | |
|--|
| C. Change the state of a unit mass lead at its melting point. |
| D. Change the state of a unit mass of lead at its boiling point. |

21.

Which of the following is common to evaporation and boiling? They

- | |
|---------------------------------------|
| A. Take place at any temperature. |
| B. Are surface phenomena. |
| C. Involve change of state |
| D. Take place at a definite pressure. |

22.

Mercury is suitable as a barometric fluid because it

- | |
|---------------------------------------|
| A. Expands uniformly |
| B. Is opaque |
| C. Is several times denser than water |
| D. Is a good conductor of heat |

23.

Which of the following properties makes metals ideal for cooking utensils?

- | |
|----------------------------------|
| A. High coefficient of expansion |
| B. Good conduction of heat |
| C. Low specific heat capacity |
| D. Poor radiation of heat. |

24.

A gas occupies a volume of 300cm³ at a temperature of 27°C. What is its volume at 54°C, when the pressure is constant?

- | | |
|------------------------|------------------------|
| A. 150 cm ³ | B. 273 cm ³ |
| C. 327 cm ³ | D. 600 cm ³ |

25.

When two objects P and Q are supplied with the same quantity of heat, the temperature change in P is observed to be twice that of Q. The mass of P is half that of Q the ratio of the specific heat capacity of P to Q is

- | | |
|----------|----------|
| A. 1 : 4 | B. 4 : 1 |
| C. 1 : 1 | D. 2 : 1 |

26.

Which of the following is true of sound?

- | |
|--|
| A. Sound travels faster in air at 20°C than at 30°C. |
| B. The frequency of a given sound wave changes when it crosses the boundary separating two media.. |
| C. The wavelength of a given sound wave in air decreases as the temperature increases. |
| D. Sound waves cannot be reflected. |

27.

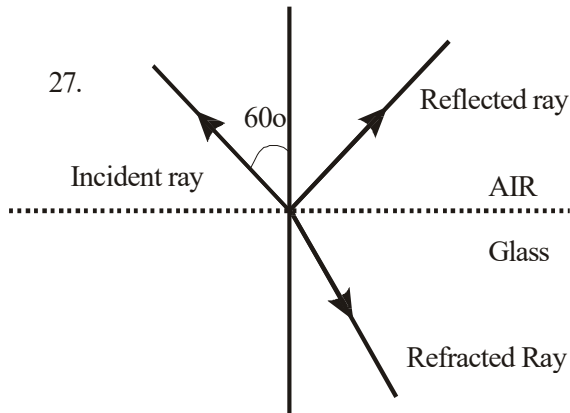

In Fig. 6, a ray of light in air strikes a glass plate at an angle of incidence of 60° . The reflected ray is observed to be perpendicular to the refracted ray. What is the refractive index of the glass?

- A. 1.73 B. 1.50
C. 0.87 D. 0.57.

28. A lens of focal length 12.0cm forms an upright image three times the size of a real object. The distance between the object and the image is

- A. 8.0 cm B. 16.0 cm
C. 24.0 cm D. 32.0 cm

29. In which of the following arrangements is the wavelength in an increasing order?

- A. Gamma rays, infra-red rays, X-rays, radiowaves.
B. Gamma rays, X-rays, infra-red rays, radiowaves.
C. Radiowaves, X-rays, gamma rays, infra-red rays.
D. Infra-red rays, radiowaves, X-rays, gamma rays.

30. If the refractive index of glass is 1.5, what is the critical angle at the air-glass interface?

- A. $\sin^{-1} \frac{1}{2}$ B. $\sin^{-1} \frac{2}{3}$
C. $\sin^{-1} \frac{3}{4}$ D. $\sin^{-1} \frac{8}{9}$

31. A dentist obtains a linear magnification of 4 of a hole in a tooth by placing a concave mirror at a distance of 2.0cm from the tooth. The radius of curvature of the mirror is

- A. 5.3 cm B. 3.2 cm
C. 2.7 cm D. 1.6 cm.

32. What is the effect of the increase in the size of the hole of a pin-hole camera on the image? It

- A. Gives a blurred image.
B. Corrects for chromatic aberration
C. Magnifies the image
D. Brings the image into the sharper focus.

33. A pencil is placed vertically between a concave mirror and its focal point. The image of the pencil in the mirror will be

- A. Real inverted and diminished
B. Virtual, inverted and enlarged
C. Real, erect and enlarged.
D. Virtual, erect and enlarged.

34. A wave of frequency 10 HZ forms a stationary wave pattern in a medium where the velocity is 20 cm s^{-1} . the distance between adjacent nodes is

- A. 1.0 cm B. 1.5 cm
C. 2.0 cm D. 5.0 cm

35

35.

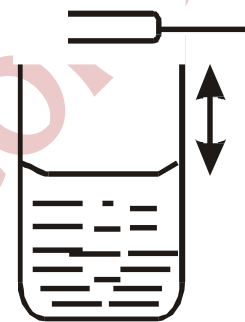

Fig. 7

In Fig. 7, a resonance tube experiment is performed using one turning fork. As the water level is lowered the first resonance is obtained when the length of the air column $l = \lambda/4$. The second resonance is obtained when l equals

- A. $\lambda/2$
B. $3\lambda/4$
C. λ
D. $3\lambda/2$.

36. Which of the following is true of the loudness of sound? It

- A. Depends on the square of the amplitude of the vibrating body.
B. Is proportional to the distance of the observer from the source of the sound.
C. Is greatest in vacuum
D. Is independent of frequency.

37. A man clapping his hands at regular intervals observes that the echo of a clap coincides with the next clap. If the reflecting cliff is 160m away and the speed of sound is 320 m s^{-1} , what is the frequency of the clapping?

- A. 1 Hz B. 2 Hz
C. 4 Hz D. 8 Hz.

38. The vibration of an air column produces the sound in the
- A. Piano B. Guitar
C. Flute
D. School handbell.

39.

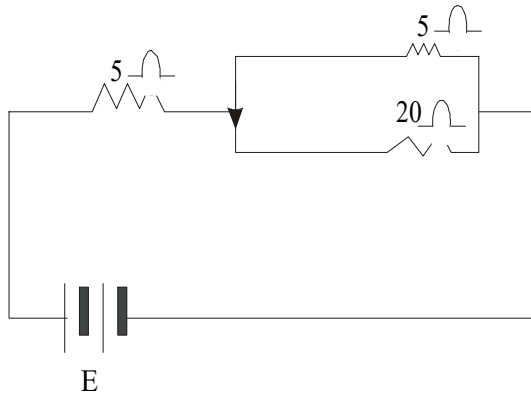

Fig. 8.

In Fig. 8, E is an accumulator with negligible internal resistance. If the e.m.f. is 9.0V, then the total current is

- A. 0.3A B. 0.8A
C. 1.0A D. 1.8A

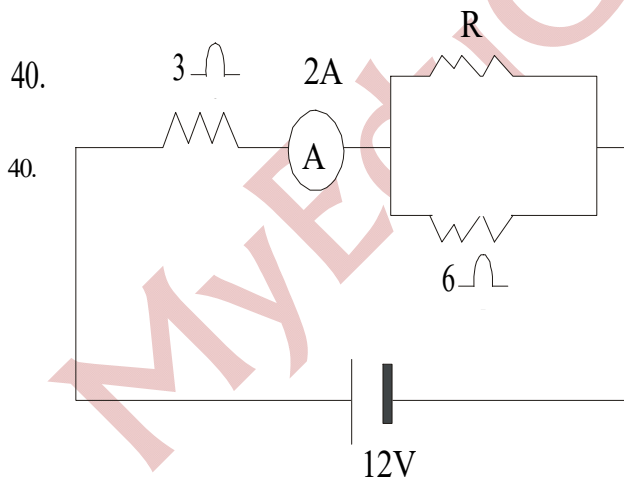

Fig. 6.

In Fig. 9, the value of R is

- A. 3 Ohms
B. 4 Ohms
C. 5 Ohms
D. 6 Ohms

41. Which of the following is *NOT* a part of the a.d.c. electric motor?
- A. Field-magnet
B. Armature
C. Commutator
D. Transformer.

42. Which of the following is stored by a dry Leclanche cell?
- A. Electrical power
B. Kinetic energy
C. Electric current
D. Chemical energy.

43. Which of the following arrangements will produce an equivalent resistance of 1.5Ω from three 1Ω resistors?

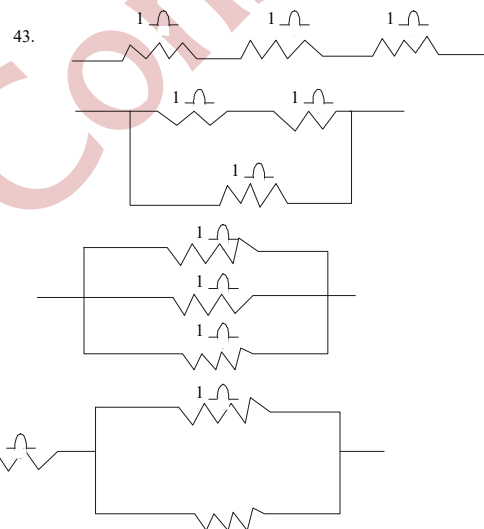

44. Which of the following is true of magnetism?
- A. Iron fillings cling mainly round the ends of a bar magnet.
B. The freely suspended bar magnet comes to rest in the geographic north-south direction.
C. Like poles attract.
D. Lodestone is a non-magnetic oxide.

45. The angle between the magnetic meridian and the geographic meridian at a locality on the earth is the
- A. Longitude of the locality.
B. Angle of inclination at the locality
C. Latitude of the locality
D. Angle of declination of the locality.

46. The sign of the charge on a charged glass rod may be determined with
- A. A charged electroscope
B. An uncharged electroscope
C. A galvanometer
D. An electrometer.

47. The diagrams below depict the current induced in a coil as a result of the relative motion between it and a bar magnet. Which of the diagrams illustrates the direction of the induced current?

47.

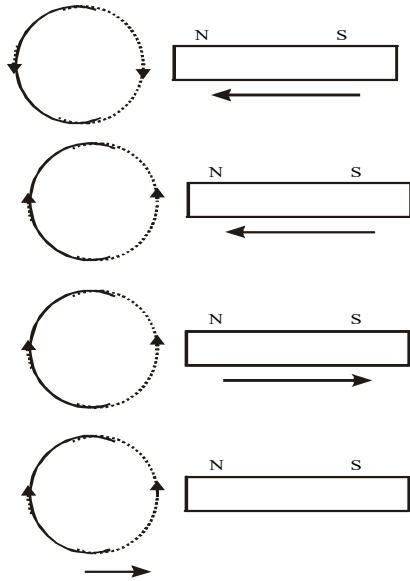

48. If the inclination at Ibadan is 70° S, this means that
- The angle between the geographic meridian and the magnetic meridian at Ibadan is 7°
 - The earth's resultant magnetic intensity at Ibadan makes angle 7° with the horizontal direction
 - A magnetic needle will be inclined at 7° to the vertical at Ibadan.
 - The north pole of a magnetic needle dips downwards at Ibadan.
49. The wavelength of ultraviolet radiation is 400nm . If the speed of light in air is $3 \times 10^8\text{m s}^{-1}$, then the frequency of the ultraviolet radiation is
- $1.3 \times 10^{15}\text{Hz}$
 - $7.5 \times 10^5\text{Hz}$
 - $1.2 \times 10^{11}\text{Hz}$
 - $7.5 \times 10^{14}\text{Hz}$
50. Which of the following is most strongly deflected by a magnetic field?
- gamma rays
 - alpha particles
 - beta particles
 - X-rays.

Physics 1987

1. Which of the following units is equivalent to kg ms^{-1} ?
- Ns^{-1}
 - Nms
 - Ns
 - Js^{-1}
2. A man walks 8km north and then 5km in a direction 60° east of north. Find the distance from his starting point.
- 11.36km
 - 12.36km
 - 13.00km
 - 14.36km

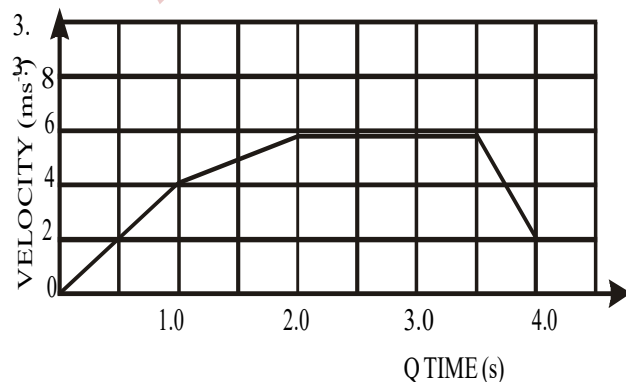

The velocity – time graph above describes the motion of a particle between two points P and Q. What is the distance between P and Q?

- 17.0m
 - 18.0m
 - 22.5m
 - 30.0m
4. A jet engine develops a thrust of 270N s when the velocity of the exhaust gases relative to the engine is 300m s^{-1} . What is the mass of the material ejected per second?
- 81.00kg
 - 9.00kg
 - 0.90kg
 - 0.09kg

5.



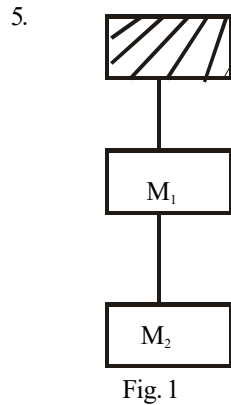
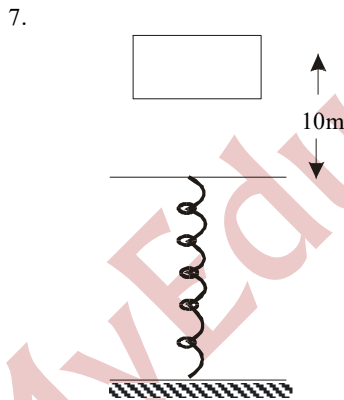

Figure 1 above shows two connected bodies of masses m_1 and m_2 in equilibrium under gravity. The

- A. $(m_1 - m_2)g$ B. $m_1 g$
 C. $\frac{m_1 m_2}{2} g$ D. $(m_1 + m_2)g$

6. An elevator of mass 4800kg is supported by a cable which can safely withstand a maximum tension of 60 000N. the maximum upward acceleration the elevator can have is

- A. $2.5m s^{-2}$ B. $5.0m s^{-2}$
 C. $7.5m s^{-2}$ D. $10.0m s^{-2}$
 ($g = 10m s^{-2}$)



A 50.0kg block is dropped on a spring from a point 10m above (Fig. 2). If the force constant of the spring is $4.0 \times 10^4 Nm^{-1}$, find the maximum compression of the spring.

- A. 1.25m B. 0.50m
 C. 0.25m D. 0.05m
 ($g = 10 ms^{-2}$)

8. A constant force of 40N acting on a body initially at rest gives an acceleration of $0.1ms^{-2}$ for 4s. Calculate the work done by the force.

- A. 8 J B. 10 J
 C. 32 J D. 160 J

9. A body rolls down a slope from a height of 100m. Its velocity at the foot of the slope $20ms^{-1}$. What percentage of its initial potential energy is converted into kinetic energy?

- A. 40% B. 35%
 C. 20% D. 15%
 ($g = 10ms^{-2}$)

10.

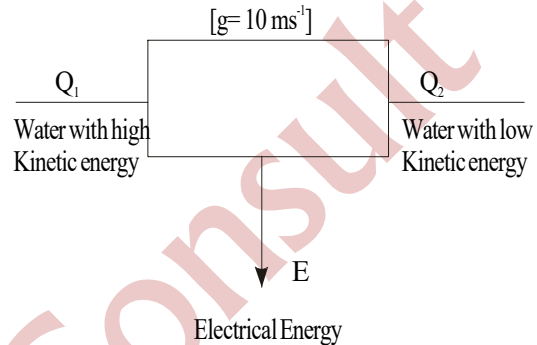

Fig. 3.

Figure 3 above represents the main sequence of energy conversion at Kainji dam. The efficiency of the system is

- A. $\frac{Q_1}{Q_2}$
 B. $\frac{E}{Q_1}$
 C. $\frac{E}{(Q_1 - Q_2)}$
 D. $\frac{E}{(Q_1 + Q_2)}$

11. The coefficient of static friction between a 40kg crate and a concrete surface is 0.25. Find the magnitude of the minimum force needed to keep the crate stationary on the concrete base inclined at 45° to the horizontal. [$g = 10ms^{-2}$]

- A. 400N B. 300N
 C. 283N D. 212N

12. If a beaker is filled with water, it is observed that the surface of the water is not horizontal at the glass-water interface. This behaviour is due to

- A. Friction B. Viscosity
 C. Surface tension D. Evaporation.

13. The mechanical advantage (MA) of an inclined plane depends on

- A. Its length
 B. Its height
 C. The product of its length and height
 D. The ratio of its length and its height.

14. A load of 5N gives an extension of 0.56cm in a wire which obeys Hooke's law. What is the extension caused by a load of 20N?
 A. 1.12 cm B. 2.14 cm
 C. 2.24 cm D. 2.52 cm.
15. A cube of side 10cm and mass 0.5kg floats in a liquid with only $\frac{1}{5}$ of its height above the liquid surface. What is the relative density of the liquid?
 A. 0.125 B. 0.250
 C. 0.625 D. 2.500.
16. The distance between the fixed points of centigrade thermometer is 20cm. What is the temperature when the mercury level is 4.5cm above the lower mark?
 A. 22.5°C B. 29.0°C
 C. 90.0°C D. 100.0°C

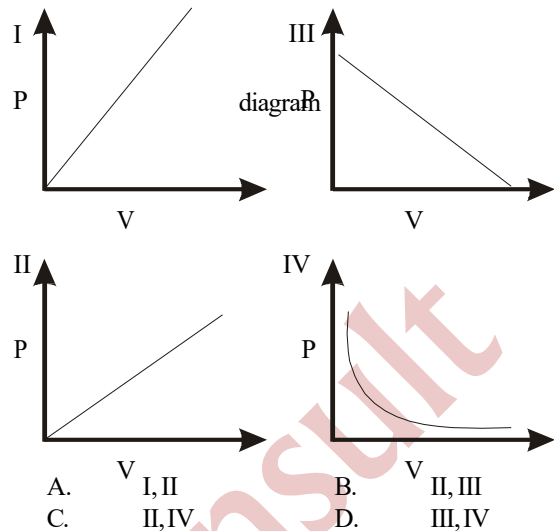

17. A metallic strip of iron and brass was heated. Which of the following diagrams accurately illustrates the shape of the strip after heating?

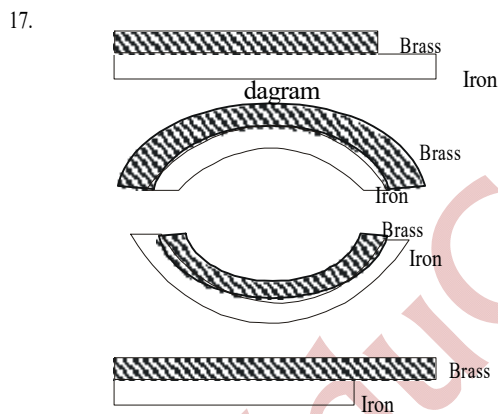

18. The length of a side of a metallic cube at 20°C is 5.0cm. Given that the linear expansivity of the metal is $4.0 \times 10^{-5} \text{ K}^{-1}$ Find the volume of the cube at 120°C.
 A. 126.50 cm³ B. 126.25 cm³
 C. 126.00 cm³ D. 125.00 cm³
19. As a result of air at the top of a barometer, the height of the mercury column is 73.5cm when it should be 75.0cm; the volume of the space above the mercury is 8.0 cm³ Calculate the correct barometric height when the barometer reads 74.0cm and the volume of the space above the mercury is 6.0 cm³.
 A. 72.0cm B. 74.5cm
 C. 75.1 cm D. 76.0cm
20. A fixed quantity of gas is subjected to various pressures P and the corresponding volumes V measured at a constant temperature. Which of the following graphs best represent the results?

21. Hot water is added to three times its mass of water at 10°C and the resulting temperature is 20°C. What is the initial temperature of the hot water?
 A. 100°C B. 80°C
 C. 50°C D. 40°C

22. 22,000J of heat is required to raise the temperature of 1.5kg of paraffin from 20°C. Calculate the specific heat capacity of paraffin.
 A. 1466J kg⁻¹ °C⁻¹
 B. 2933J kg⁻¹ °C⁻¹
 C. 4400J kg⁻¹ °C⁻¹
 D. 5866J kg⁻¹ °C⁻¹

23. Calculate the amount of heat required to convert 2kg of ice at -2°C to water at 0°C. (Specific heat capacity of ice = 2090J kg⁻¹ °C⁻¹, specific latent heat of fusion = 333kJ kg⁻¹).
 A. 666J B. 8 360J
 C. 666000J D. 674 360J.

24. In which of the following are the substances arranged in descending order of their thermal conductivities?
 A. Copper, steel, glass
 B. Steel, copper, glass
 C. Steel, glass, copper
 D. Copper, glass, steel.

25. The vacuum in the Thermos flask helps to reduce heat transfer by
 A. Convection and radiation
 B. Convection and conduction
 C. Conduction and radiation
 D. Radiation only.

26. Which of the following phenomena explains the fact that a house whose roof is coated with white

- paint will be cooler in the hot season than one coated with black paint?
- A. Conduction B. Convection
C. Refraction D. Reflection.
27. A wave has a frequency of 2 Hz and a wavelength of 30cm. The velocity of the wave is
A. 60.0m s^{-1} B. 6.0m s^{-1}
C. 1.5m s^{-1} D. 0.6m s^{-1}
28. A boat at anchor is rocked by waves whose crests are 100m apart and whose velocity is 25m s^{-1} . At what interval does the wave crest reach the boat?
A. 2,500.00s B. 75.00s
C. 4.00s D. 0.25s
29. Which of the following instruments has a pure tone?
A. Guitar
B. Vibrating string
C. Turning fork
D. Siren.
30. The lowest note emitted by a stretched string has a frequency of 40 Hz. How many overtones are there between 40 hZ and 150 Hz?
A. 1 B. 2
C. 3 D. 4.
31. When the length l of a piece of wire under constant tension is varied, the relationship of the frequency of vibration f with l is
A. $f \propto l$ B. $f \propto l^{1/2}$
C. $f \propto l$ D. $f \propto l^{-1}$
32. Which of the following statements supports the assumption that light travels in straight lines?
A. Light can be diffracted
B. A source of light produces distinct shadows of opaque objects
C. A source of light produces interference patterns on a suitably placed screens.
D. Light can be reflected.
33. If an object is placed in front of two mirrors inclined at 90° , how many images will be formed?
A. Five B. Four
C. Three D. Two.
34. An object 3.0cm high is placed 60.0cm from a converging lens whose focal length is 20.0cm. Calculate the size of the image formed.
A. 0.5cm B. 1.5cm
C. 2.0cm D. 6.0cm
35. A pool of water appears to be 1.0m deep when viewed vertically from above. If the refractive index

of water is 1.33. what is the actual depth of the pool?

- A. 0.75 m B. 1.013 m
C. 1.330 m D. 13,3000m

36. A ray of light is incident at an angle of 30° on one top surface of a parallel-sided glass block of refractive index 1.5. The ray finally emerges from the lower surface. What is the angular deviation of the emergent ray?
A. 60° B. 39°
C. 28° D. 0°
37. Four lenses are being considered for use as a microscope objective. Which of the following focal lengths is most suitable?
A. -5mm B. +5mm
C. -5cm D. +5cm
38. If the angle of declination in a place is 10°E , calculate the true geographic bearing if the compass reads $\text{N}40^\circ\text{E}$.
A. $\text{N}50^\circ\text{E}$ B. $\text{N}40^\circ\text{E}$
C. $\text{N}30^\circ\text{E}$ D. $\text{N}25^\circ\text{E}$

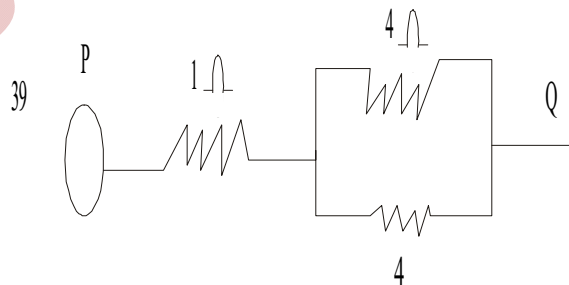

Fig. 4.

In Fig. 4 above, a voltage V is applied across the terminals P and Q. the voltage across the 1 resistor is

- A. $\frac{V}{8}$ B. $\frac{V}{4}$
C. $\frac{V}{3}$ D. $\frac{V}{2}$

40. Two capacitances of $6\mu\text{F}$ and $8\mu\text{F}$ are connected in series. What additional capacitance must be connected in series with this combination to give a total of $3\mu\text{F}$?
A. $3\mu\text{F}$ B. $16\mu\text{F}$
C. $24\mu\text{F}$ D. $30\mu\text{F}$.

41.

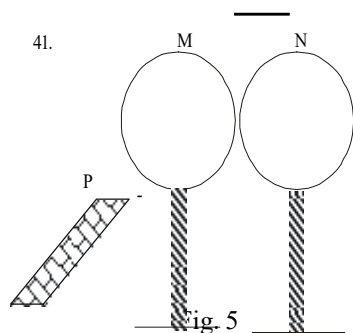

In Fig. 5 above, M and N are insulated metal spheres in contact. A negatively charged ebonite rod P is brought near M. when M and N are separated and the rod is taken away, which of the following statements is *CORRECT*?

- A. Both M and N have acquired negative charges
 - B. Both M and N have acquired positive charges
 - C. M has acquired negative charge and N positive charge
 - D. M has acquired positive charge and N negative charge.
42. When a transformer has more secondary windings than primary winding, it
- A. Has a smaller secondary current
 - B. Has a greater power output
 - C. Is a step-down transformer
 - D. Increases the total energy output.
43. A current of 0.5A flows through a resistor when connected to a 40-V battery. How much energy is dissipated in 2 minutes?
- A. 1 200J
 - B. 1 500J
 - C. 2 400J
 - D. 96 000J.
44. The direction of the magnetic field at a point in the vicinity of a bar magnet is
- A. Always towards the north pole of the magnet
 - B. Always away from the south pole of the magnet
 - C. Along the line joining the point to the neutral point
 - D. In the direction the north pole of a compass needle would point.
45. When two parallel wires carry currents in opposite directions, the force on either wire is
- A. Away from the other wire
 - B. Zero, because the currents cancel each other
 - C. Twice as much as when the currents are in the same direction
 - D. Towards the other wire.

46.

A galvanometer of resistance 20 is to be provided with a shunt that $\frac{1}{10}$ of the whole current in a circuit passes through the galvanometer. The resistance of the shunt is

- A. 2.00
- B. 2.22
- C. 18.00
- D. 18.22

47.

What type of reaction is represented by the following scheme?

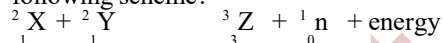

- A. Fusion reaction
- B. Fission reaction
- C. Chain reaction
- D. Radioactive decay.

48.

Which of the following statements is *TRUE* of photoelectric effect?

- A. It cannot occur in liquids
- B. The energy of the emitted electron is independent of the work function of the surface
- C. The energy of the emitted electron depends on the wavelength of the incident light
- D. The greater the intensity of the incident, the greater the energy of the emitted electron.

49.

Isotopes are nuclei which have

- A. The same number of neutrons and electrons
- B. Equal number of electrons and protons
- C. The same atomic number but different number of neutrons
- D. The same number of total particles.

50.

A radioactive sample initially contains N atoms. After three half-lives the number of atoms that have disintegrated is

- A. $\frac{N}{8}$
- B. $\frac{3N}{8}$
- C. $\frac{5N}{8}$
- D. $\frac{7N}{8}$

Physics 1988

1. Which of the following diagrams correctly represents the relationship between the time (T) of swing of a simple pendulum and its length (l)?

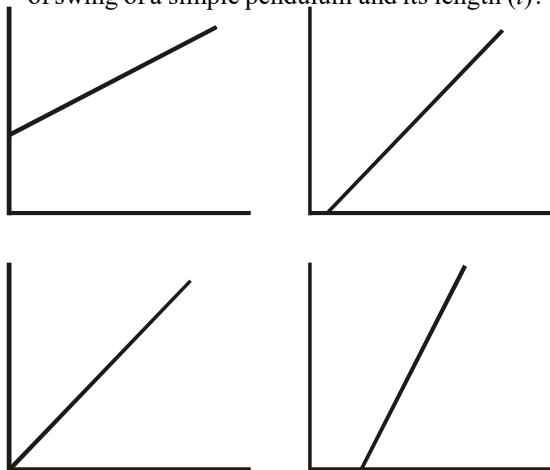

2. Which of the following are the correct SI units of the quantities indicated?

- I N (Force)
- II Nm^{-1} (Torque)
- III Watt (power)
- IV kg ms^{-2} (Momentum).

- A. I and II only
- B. I, II and III only
- C. I, II and IV only
- D. I and III only.

3. A lorry travels 10km northwards, 4km eastwards, 6km southwards and 4km westwards to arrive at a point T. What is the total displacement?

- A. 6km south
- B. 4km north
- C. 6km north
- D. 4km east.

4. Two forces whose resultant is 100N, are at right angles to each other. If one of them makes an angle of 30° with the resultant, determine its magnitude.

- A. 8.66N
- B. 50.0N
- C. 57.7N
- D. 86.6N

5. Which of the following quantities are scalars?

- I Electrical potential
- II Torque
- III Momentum
- IV Kinetic energy

- A. II and III only
- B. I and II only
- C. III and IV only
- D. I and IV only.

6. A particle starts from rest and moves with a constant acceleration of 0.5 m s^{-2} . The distance covered by the particle in 10s is

- A. 2.5m
- B. 5.0m
- C. 25.0m
- D. 50.0m

7. When taking a penalty kick, a footballer applies a force of 30.0N for a period of 0.05s. If the mass of the ball is 0.075kg, calculate the speed with which the ball moves off.

- A. 4.50 m s^{-1}
- B. 11.25 m s^{-1}
- C. 20.00 m s^{-1}
- D. 45.00 m s^{-1}

8. A 20-toothed gear wheel drives a 60-toothed one, if the angular speed of the smaller wheel is 120 rev s^{-1} , the angular speed of the wheel is

- A. 3 rev s^{-1}
- B. 40 rev s^{-1}
- C. 360 rev s^{-1}
- D. $2\ 400\text{ rev s}^{-1}$

- 9.

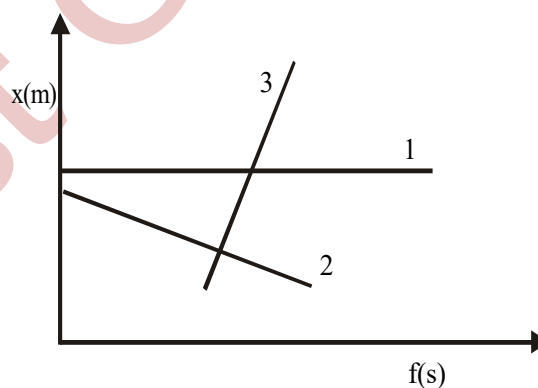

The figure above show the displacement – time graphs for three different motions. Which of the following statements is correct?

- A. Graph 2 corresponds to the highest velocity
- B. Graph 1 corresponds to zero velocity
- C. Graph 3 corresponds to a particle moving in the negative x direction.
- D. Graph 2 corresponds to a particle moving in the positive x directions.

- 10.

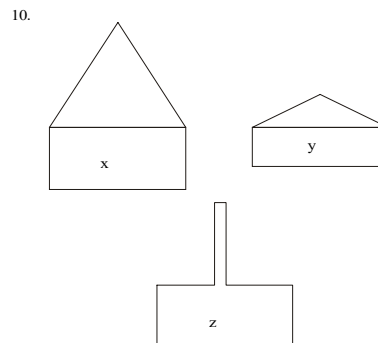

The figures above show three different ways of hanging a heavy picture from a hook. The tension in the string would be

- A. Greatest in X
- B. Greatest in Y
- C. Greatest in Z
- D. Same in each one.

11. How long will it take a 60kg man to climb a height of 22m if he expended energy at the rate of 0.25kW?

- A. 5.3s
- B. 34.5s
- C. 41.6s
- D. 52.8s

$[g = 10\text{ms}^{-2}]$

12. A force, 10N, drags a mass 10kg on a horizontal table with an acceleration of 0.2m s^{-2} . If the acceleration due to gravity is 10m s^{-2} , the coefficient of friction between the moving mass and the table is

- A. 0.02 B. 0.08
- C. 0.20 D. 0.80

13. Which of the following graphs correctly describes the variation of the mechanical advantage with load for a simple machine whose velocity ratio is 3?

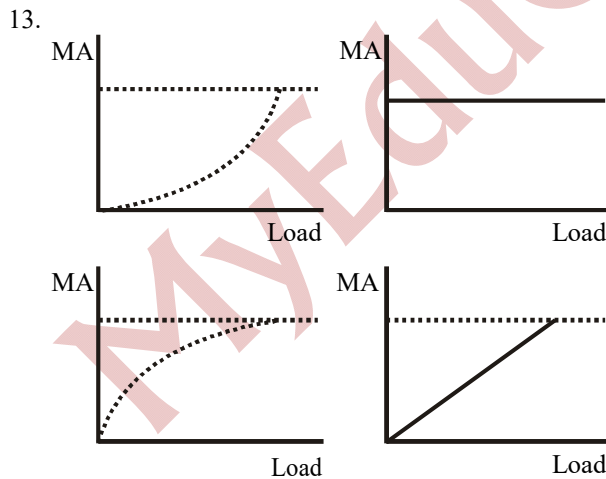

14. A body whose mass is 2kg and has a volume of 500cm just floats when completely immersed in a liquid. Calculate the density of the liquid.

- A. $4.0 \times 10^2 \text{kg m}^{-3}$
- B. $4.0 \times 10^3 \text{kg m}^{-3}$
- C. $1.0 \times 10^3 \text{kg m}^{-3}$
- D. $1.0 \times 10^6 \text{kg m}^{-3}$

15.

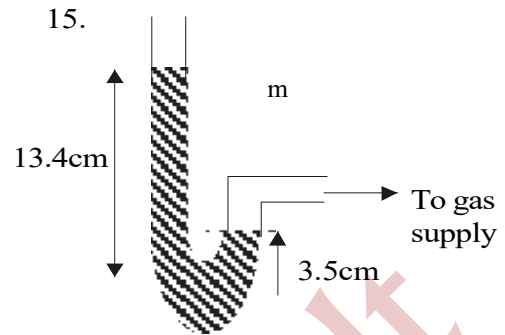

When one arm of a U-tube manometer is connected to a gas supply, the levels of mercury in the two arms of the U-tube are as shown in the diagram above. If the atmospheric pressure is 76.0cm Hg, the gas pressure is

- A. 62.6cmHg B. 72.5cmHg
- C. 79.5cmHg D. 85.9cmHg

16. The product PV where P is pressure and V is volume has the same unit as

- A. Force B. Power
- C. Energy D. Acceleration

17. The amount of heat needed to raise the temperature of 10kg of copper by 1K is its

- A. Specific heat capacity
- B. Heat capacity
- C. Latent heat
- D. Internal heat.

18. A tap supplies water at 25°C while another supplies water at 75°C . If a man wishes to bathe with water at 40°C , the ratio of the mass of cold water to the mass of hot water required is

- A. 1 : 3 B. 15 : 8
- C. 7 : 3 D. 3 : 1

19. Which of the following graphs clearly illustrates the temperature change which takes place as a piece of ice at -10°C is heated slowly?

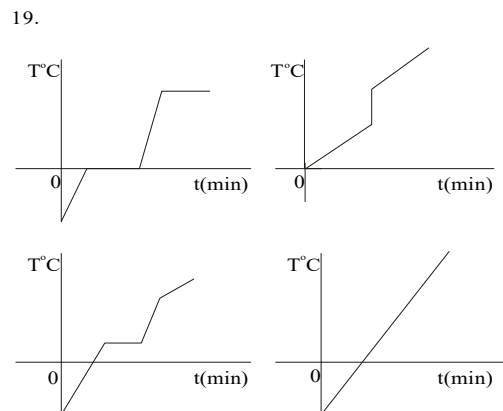

20. When heat is applied to one end of a metal rod, the molecules at the other end soon begin to vibrate with greater amplitude than before because heat has been transfer by
- A. Radiation B. Convection
C. Conduction D. Evaporation.

21. Which of the following media allow the transmission of sound waves through them?
- I Air
II Liquids
III Solids
- A. I and II only
B. I and III only
C. II and III only
D. I, II and III.

22.

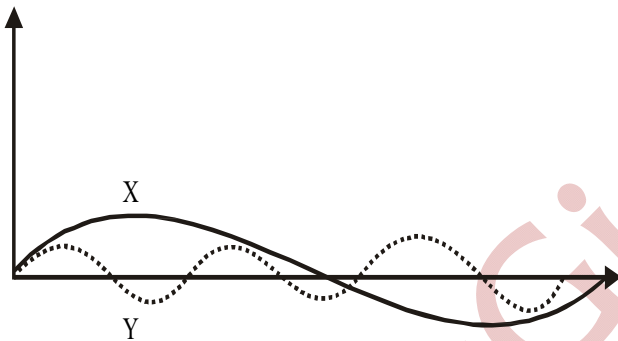

The diagram above shows two waveforms X and Y. If the frequency is 30 HZ, what is the frequency of Y?

- A. 12Hz B. 19Hz
C. 60Hz D. 75Hz
23. Which of the following properties is/are common to all waves?
- I Diffraction
II refraction
III Interference
- A. I only B. III only
C. I and III only D. I, II and III.
24. A piano wire 0.5m long has a total mass of 0.01kg and is stretched with a tension of 800N. Calculate the frequency of the wire when it sounds its fundamental note.
- A. 200Hz B. 100Hz
C. 4 Hz D. 2 Hz.

25. A note is called an octave of another note when
- A. Its frequency is twice that of the first note
B. Its frequency is half that of the first note
C. The notes have the same fundamental frequency
D. Its periodic time is twice that of the first note.

26. Which of the following factors affects the speed of sound in air?
- I Temperature
II Pressure
III Frequency.
- A. I only B. II only
C. I and II only D. II and III only.

27. The speed of sound in air at sea-level is 340m s^{-1} while that of light is $300,000\text{km s}^{-1}$. How far (to the nearest metre) from the center of thunderstorm is an observer who hears a thunder 2s after a lightning flash?
- A. 170m B. 340m
C. 600m D. 680m.

28. A slight loading of a turning fork has the effect of
- A. Decreasing its amplitude
B. Increasing its amplitude
C. Decreasing its frequency
D. Increasing its frequency

29. Two strings of the same length and under the same tension give notes of frequencies in the ratio 4 : 1. The masses of the strings are in the corresponding ratio of
- A. 2 : 1 B. 1 : 2
C. 1 ; 4 D. 1 : 16

30. To obtain a magnification of 2.5, how far should an object be placed from the pole of a thin converging lens of focal length 10.20m?
- A. 0.13m B. 0.25m
C. 0.28m D. 0.50m

31.

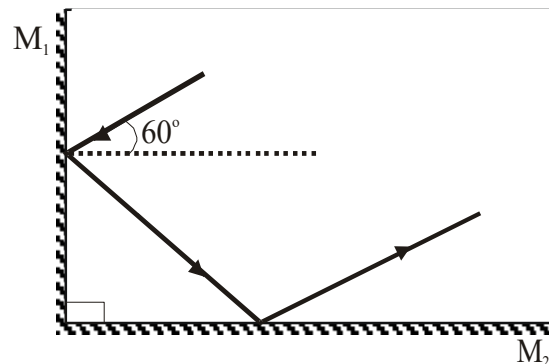

In the figure above, what is the angle of reflection of the ray of light at mirror M^2 ?

- A. 90° B. 60°
 C. 45° D. 30°

32. An object is placed 10 cm in front of a concave mirror of focal length 15 cm. What is the position and nature of the image formed?

- A. 30 cm and virtual
 B. 6 cm and real
 C. 6 cm and virtual
 D. 30 cm and real.

33. Which of the following phenomena explain the formation of a mirage

- I Reflection
 II Refraction
 III Diffraction

- A. I and II only
 B. II and III only
 C. I and III only
 D. I, II and III.

34. When white light is dispersed by a spectrometer, the component having the shortest wavelength is

- A. Orange B. Green
 C. Violet D. Red.

35. Which of the following statements is *TRUE* of ultra-violet, visible and infra-red rays?

- A. They are all electromagnetic waves with the same wavelength.
 B. Ultra-violet rays have shorter wavelengths than infra-red rays and produce fluorescence.
 C. Infra-red rays have shorter wavelength than visible light and produce the sensation of heat.
 D. The wavelengths increase in the sequence: visible, ultra-violet, infra-red.

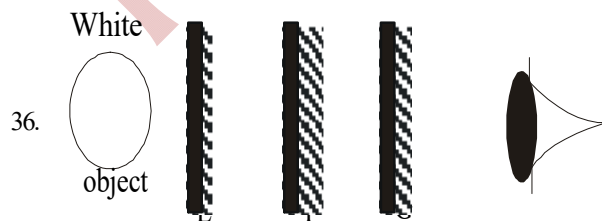

E, F and G are yellow, red and cyan transparent light filters respectively. The colour of a white

opaque object when viewed through the arrangement of the filters above is

- A. Yellow B. Red
 C. Black D. Blue

37.

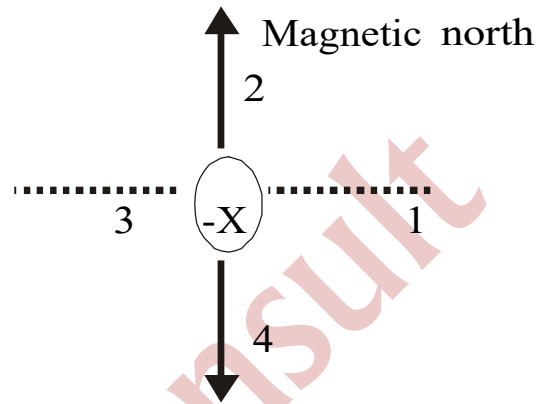

The wire X in the figure above is at right angles to the plane of the paper and carries a current into the paper. At which of the point labeled 1 – 4 will the magnetic flux density due to this current be in the same direction as that of the horizontal component of the earth's magnetic field?

- A. 1 B. 2
 C. 3 D. 4.

38. A spectrum of sunlight is said to be impure when

- A. It is made of only three colours
 B. It has no red colour in it
 C. The different colours in it overlap
 D. It does not contain white light.

39. A cell of internal resistance 2 ohms supplies current to a 6-ohm resistor. The efficiency of the cell is

- A. 12.0%
 B. 25.0%
 C. 33.3%
 D. 75.0%

40. When a resistance R is across a cell, the voltage across the terminals of the cell is reduced to two-thirds of its nominal value. The internal resistance of the cell is

- A. $\frac{1}{3} R$
 B. $\frac{1}{2} R$
 C. $\frac{2}{3} R$
 D. R

41.

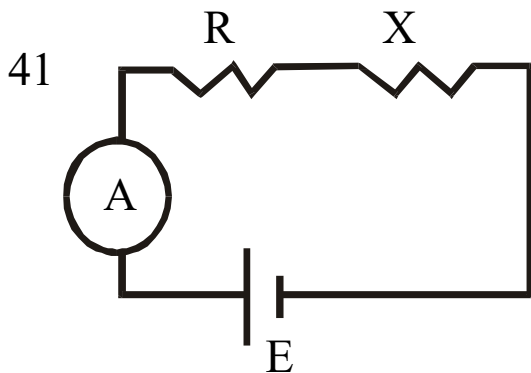

In the circuit above, the ammeter reads a current of 3 amps. When R is 5 ohms and reads 6 amps when R is 2 ohms. The value of the unknown resistance X is

- A. 1
- B. 2
- C. 3
- D. 4

42. Which of the following combinations of 2 μF capacitors will give an effective capacitance of 3 μF across terminal XY?

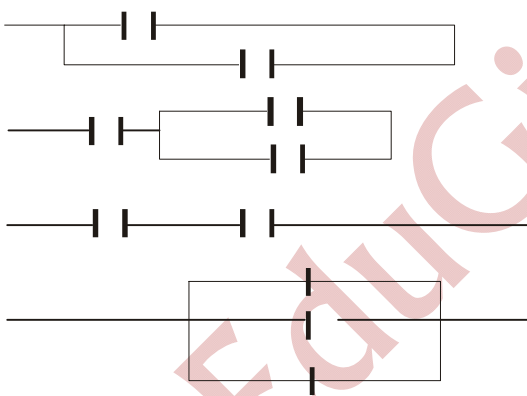

43. A household refrigerator is rated 200 watts. If electricity costs 5k per kWh, what is the cost of operating it for 20 days?

- A. N4:80
- B. N48:00
- C. N480:00
- D. N4 800:00

44. Which of the following instruments consumes the highest current?

Instrument	Voltage Rating	Power Rating
A. Electric iron	250V	1kW
B. Television set	220V	110W
C. Torch light	6V	30W
D. Immersion heater	110V	500W

45. Which of the following ammeters may be used to measure alternating current?

- I Moving-coil ammeter
- II Moving-iron ammeter
- III Hot-wire ammeter.

- A. I and II only
- B. II and III only
- C. I and III only
- D. I, II and III.

46. The principle of operation of an induction coil is based on

- A. Ohm's law
- B. Ampere's law
- C. Faraday's law
- D. Coulomb's law.

47. A dynamo primarily converts

- A. Mechanical energy into electrical energy
- B. Electrical energy into kinetic energy
- C. Potential energy into kinetic energy
- D. Kinetic energy into potential energy.

48. In a certain fusion reaction, a deuteron (${}^2_1\text{H}$) interacts with a triton (${}^3_1\text{H}$) and produces an α -particle (${}^4_2\text{He}$) and a second product. The second product is

- A. A proton
- B. An electron
- C. A neutron
- D. A gamma ray.

49. Which of the following symbolic representations is correct for an atom X with 22 electrons and 43 neutrons?

- A. ${}^{43}_{22}\text{X}$
- B. ${}^{22}_{43}\text{X}$
- C. ${}^{65}_{42}\text{X}$
- D. ${}^{65}_{22}\text{X}$

50.

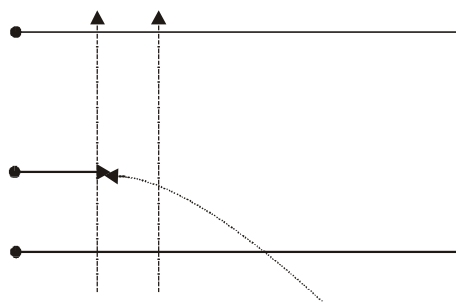

A particle is injected perpendicularly into an electric field. It travels along a curved path as depicted in the figure above. The particle is

- A. A gamma ray
- B. An electron
- C. A neutron
- D. A proton.

Physics 1989

1. Which of the following is a set of vectors?
- Force, mass and moment
 - Acceleration, velocity and moment
 - Mass, weight and density
 - Mass, volume and density

2. The magnitude of the resultant of two mutually perpendicular forces, F_1 and F_2 is 13N. If the magnitude of F_1 is 5N, what is the magnitude of F_2 ?

- 2.6N
- 8.0N
- 12.0N
- 18.0N

3. Two points on a velocity-time graph have coordinates $(5s, 10m\ s^{-1})$ and $(20s, 20m\ s^{-1})$. Calculate the mean acceleration a between the two points.

- $0.67m\ s^{-1}$
- $0.83m\ s^{-2}$
- $1.50m\ s^{-2}$
- $2.00m\ s^{-2}$

4.

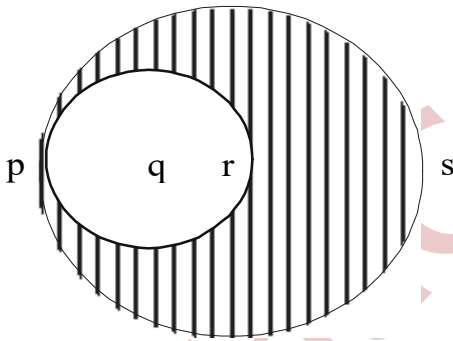

The figure above shows a uniform circular object, centre R and diameter PS. A circular section, centre Q and diameter PR is cut away from it. If PQRS is a straight line, where is the centre of gravity of the figure?

- Q
- R
- A point between P and R
- A point between R and S.

5. Which of the following graphs represents motion with uniform velocity?

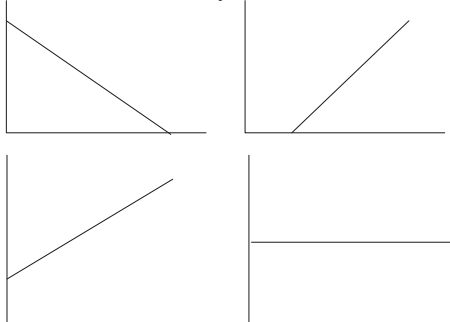

6.

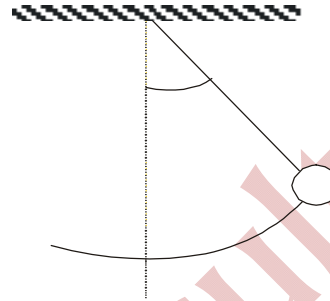

A simple pendulum of mass m moves along an arc of a circle radius R in a vertical plane as shown in the figure above. What is the work done by gravity in a downward swing through the angle Q to 0° ?

- $mgR \sin Q$
- $mgR (1 - \cos Q)$
- mgR
- $mgR (1 - \sin Q)$

7.

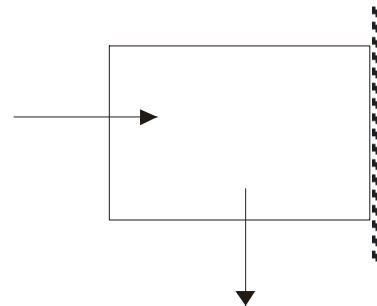

A block of mass m is held in equilibrium against a vertical wall by a horizontal force. If the coefficient of friction between the block and the wall is u , the minimum value of the horizontal force is

- umg
- $(1 - u)mg$
- $(1 + u)mg$
- $\frac{mg}{u}$

8.

A thin film of liquid is trapped between two glass plates. The force required to pull the plates apart will increase if the

- Surface tension of the liquid is reduced
- Perpendicular distance between the plates is increased.
- Area of the liquid surface in contact with the plates is increased
- Pressure of the air is decreased.

9. A block-and-tackle system is used to lift a load of 20N through a vertical height of 10cm. If the efficiency of the system is 40%, how much work is done against friction?

- A. 80J B. 120J
C. 300J D. 500J

10.

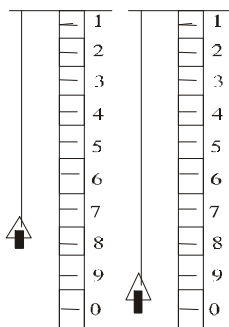

In the figure above, $W_1 = 200\text{g}$ and $W_2 = 450\text{g}$. Calculate the extension of the spring per unit load.

- [$g = 10\text{m s}^{-2}$]
A. $6.0 \times 10^{-5}\text{m N}^{-1}$
B. $2.5 \times 10^{-4}\text{m N}^{-1}$
C. $6.0 \times 10^{-4}\text{m N}^{-1}$
D. $2.5 \times 10^{-2}\text{m N}^{-1}$

11. Which of the following devices are used to measure pressure?

- I Aneroid barometer
II Hydrometer
III Hygrometer
IV Manometer.
A. I and III B. II and III
C. III and IV D. I and IV.

12. A piece of wood of mass 40g and uniform cross-sectional area of 2cm^2 floats upright in water. The length of the wood immersed is

- A. 80cm B. 40cm
C. 20cm D. 2cm

13. The pressure on the gas of constant gas thermometer at the ice point is 325mm of mercury and at the steam point 875mm of mercury. Find the temperature when the pressure of the gas is 190mm of mercury.

- A. 30k
B. 243k
C. 300k
D. 303k

14. A column of air 10.0cm long is trapped in a tube at 27°C . What is the length of the volume at 100°C ?

- A. 12.4cm
B. 13.7cm
C. 18.5cm

D. 37.0cm

15. A mass of gas at 7°C and 70cm of mercury has a volume of 1200cm^3 . Determine its volume at 27°C and pressure of 75cm of mercury.

- A. $1\ 200\text{cm}^3$
B. $1\ 378\text{cm}^3$
C. $4\ 320\text{cm}^3$
D. $4\ 629\text{cm}^3$

16. An electric heater is used to melt a block of ice, mass 1.5kg. If the heater is powered by a 12V battery and a current of 20A flows through the coil, calculate the time taken to melt the block of ice at 0°C . (Specific latent heat of fusion of ice = $336 \times 10^3\text{J kg}^{-1}$).

- A. 76.0min
B. 35.0min
C. 21.0min
D. 2.9 min.

17. From the kinetic theory of gases, temperature is a

- A. Form of energy and is proportional to the total kinetic energy of the molecules.
B. Form of energy and is proportional to the average kinetic energy of the molecules.
C. Physical property and is proportional to the total kinetic energy of the molecules.
D. Physical property and is proportional to the average energy of the molecules.

18. Which of the following correctly represents the variation of the saturated vapour pressure of water with temperature?

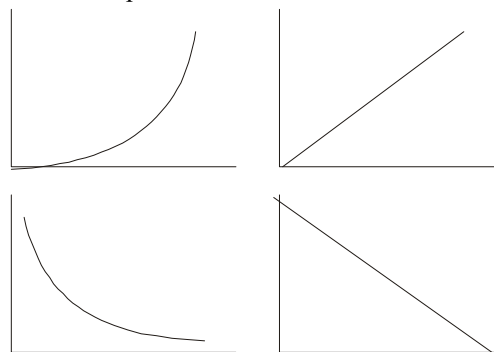

19. A vibrator of frequency 60 Hz is used in generating transverse stationary waves in a long thin wire. If the average distance between successive nodes on the wire is 45cm, find the speed of the transverse waves in the wire.

- A. 27ms^{-1} B. 54ms^{-1}
C. 90ms^{-1} D. 108ms^{-1}

20.

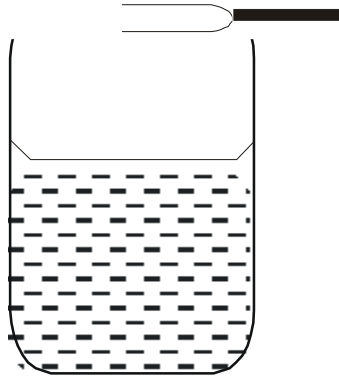

The air column as shown in the figure above is set into vibration by the turning fork. In this state of resonance, the waves in the air column will be

- A. Stationary and transverse
 B. Stationary and longitudinal
 C. Progressive and transverse
 D. Progressive and longitudinal.
21. When the tension in a sonometer wire is doubled, the waves in the air column will be
 A. $\frac{1}{\sqrt{2}}$
 B. $\frac{1}{2}$
 C. $\sqrt{2}$
 D. 2
22. In a sound wave in air, the adjacent rarefactions and compressions are separated by a distance of 17cm. If the velocity of the sound wave is 340ms^{-1} , determine the frequency.
 A. 10 Hz
 B. 20 Hz
 C. 1 000 Hz
 D. 5 780 Hz
23. In which of the following diagrams is the length of the tube equal to one wavelength?

23.

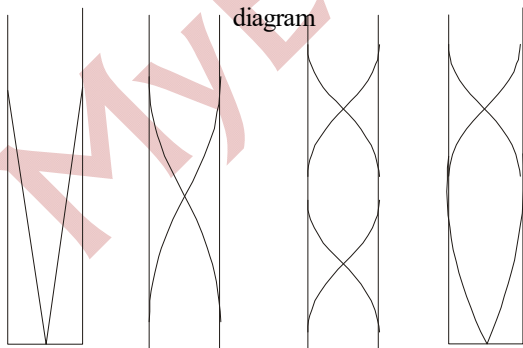

24. Light of wavelength $5000 \times 10^{-8}\text{cm}$ travels in free space with a velocity of $3 \times 10^8\text{m s}^{-1}$. What is its wavelength in glass of refractive index 1.5?

- A. $3\,333 \times 10^{-8}\text{cm}$
 B. $5\,000 \times 10^{-8}\text{cm}$
 C. $6\,666 \times 10^{-8}\text{cm}$
 D. $7\,500 \times 10^{-8}\text{cm}$

25. An object is placed $5.6 \times 10^{-4}\text{m}$ in front of a converging lens of focal length $1.0 \times 10^{-8}\text{m}$. The image formed is
 A. Real, erect and magnified
 B. Virtual, erect and magnified
 C. Real, inverted and magnified
 D. Virtual, erect and diminished.

26. The magnification of the image of an object placed in front of a convex mirror is $\frac{1}{3}$. If the radius of curvature of the mirror is 24cm, what is the distance between the object and its image?
 A. 8 cm
 B. 16 cm
 C. 24 cm
 D. 32 cm

27. The plane mirrors in a kaleidoscope are usually placed
 A. At an angle of 60°
 B. Parallel to one another
 C. Perpendicular to one another
 D. At an angle of 45°

28. A far sighted person cannot see objects that are less than 100cm away. If this person wants to read a book at 25cm, what type and focal length of lens does he need?
 A. Convex, 20cm
 B. Concave, 20cm
 C. Convex, 33cm
 D. Concave, 33cm.

29. When a yellow card is observed through a blue glass, the card would appear
 A. Black
 B. Green
 C. Red
 D. White

30. Dispersion of light by a glass prism is due to the
 A. Different hidden colours of the glass
 B. Different speeds of the various colours in glass
 C. Defects in the glass
 D. High density of glass.

31. Which of the following pairs is *NOT* part of the electromagnetic spectrum?

- I Radio waves
 II Beta rays
 III Gamma rays
 IV Alpha rays

- A. I and II
 B. III and IV
 C. I and III
 D. II and IV.

32. Two insulated charged spheres of different sizes and carrying opposite charges are connected together by a metallic conductor. Current will flow from one sphere to the other until both spheres

- A. Carry the same magnitude and sign of charge.
- B. Are at the same potential.
- C. Are at the same temperature.
- D. Are of the same size.

33. When a number of identical small magnets are arranged in a line, the strength of the resultant magnet

- A. Is largest when they are arranged end to end
- B. Is greatest when they are arranged parallel with like poles adjacent to each other.
- C. Depends only on the number of magnets provided they are parallel.
- D. Is greater when the magnets are arranged on a wooden surface than on a metal surface.

34. A bar magnet is most effectively demagnetized by

- A. Placing it in a N – S position and hitting it with a hammer.
- B. Subjecting it to an electric current from a battery
- C. Bringing its north pole in contact with the north pole of a very strong magnet
- D. Heating the magnet.

35. The resistance of a 5m uniform wire of cross-sectional area $0.2 \times 10^{-6} \text{m}^2$ is 0.425. What is the resistivity of the material of the wire?

- A. $1.10 \times 10^{-6} \text{ Ohms m}$
- B. $4.25 \times 10^{-6} \text{ Ohms m}$
- C. $2.40 \times 10^{-7} \text{ Ohms m}$
- D. $1.70 \times 10^{-8} \text{ Ohms m}$

36. Three resistors, with substances 250 Ohms 500 Ohms and 1 k Ohms are connected in series. A 6V battery is connected to either end of the combination. Calculate the potential difference between the ends of the 250 Ohms resistor.

- A. 0.20V B. 0.86V
- C. 1.71V D. 3.43V.

37. A calibrated potentiometer is used to measure the e.m.f. of a cell because the

- A. Internal resistance of a cell is small compared with that of the potentiometer.
- B. Potentiometer has a linear scale.
- C. Potentiometer takes no current from the cell
- D. Resistance of the potentiometer is less than that of a voltmeter.

38.

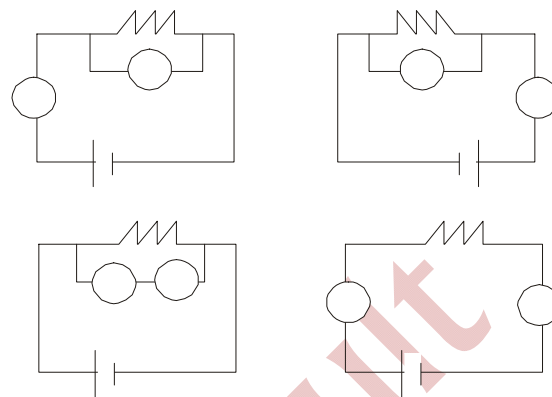

In the above circuit diagrams, A is the ammeter and V the voltmeter. Which of the circuits is correct for finding the value of the resistance R?

- A. I B. II
- C. III D. IV.

39.

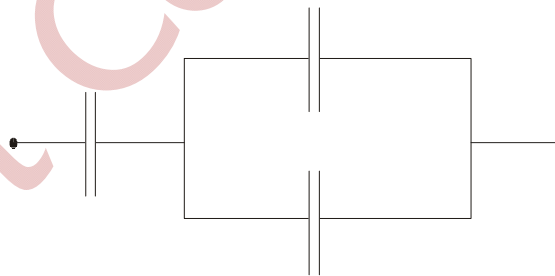

Three $2 \mu \text{F}$ capacitors are arranged as shown in the above circuit. The effective capacitance between E and F is

- A. $0.75 \mu \text{F}$
- B. $1.33 \mu \text{F}$
- C. $3.00 \mu \text{F}$
- D. $6.00 \mu \text{F}$

40.

The function of a 5-A fuse included in a circuit supplying a household refrigerator with power is to keep the

- A. Temperature of the refrigerator low and constant.
- B. Current supplied to the refrigerator below 5A.
- C. Voltage supply constant
- D. Current supplies to the refrigerator constant and above 5A.

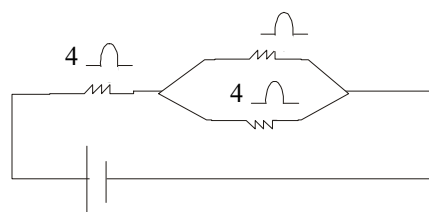

41.

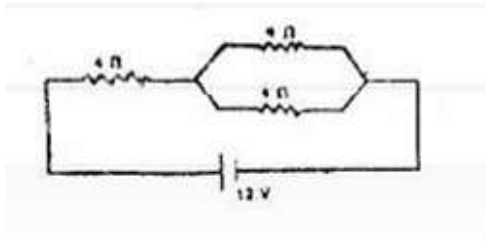

The total power drawn from the cell in the circuit diagram above is

- A. 12W B. 24W
C. 32W D. 40W

42.

Which of the following correctly represents the relationship between the temperature rise θ and the current I in an experiment to illustrate the heating effect of the electric current?

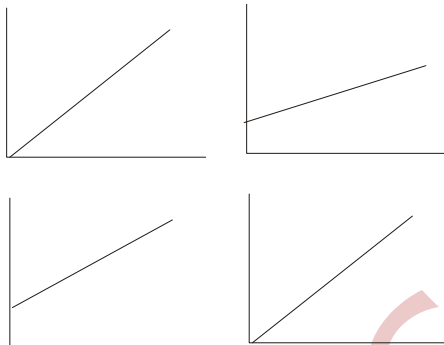

43.

An ammeter of resistance 0.1 ohms has a full-scale deflection of 50 mA. Determine the resultant full-scale deflection of the meter when a shunt of 0.011 Ohms is connected across its terminals.

- A. 400mA B. 450mA
C. 500mA D. 550mA.

44.

The electrochemical equivalent of silver is 0.0012g/C. If 36.0g of silver is to be deposited by electrolysis

on a surface by passing a steady current for 5.0 minutes, the current must be

- A. 6000 A B. 100 A
C. 10 A D. 1 A

45.

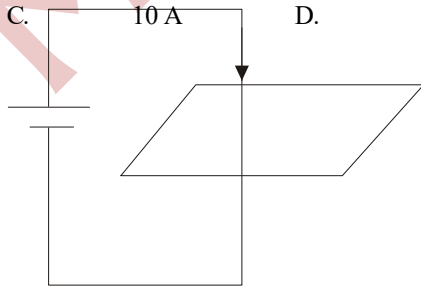

The figure above shows a conductor PQ carrying a current I in the direction shown. At a particular position near the conductor is a compass needle K. Neglecting the earth's magnetic field, the compass needle will

- A. Settle in any direction
B. Settle in a fixed direction only if conductor PQ is a magnetic material
C. Settle in a fixed direction whether conductor PQ is a magnetic material or not
D. Be stationary.

46.

A radioactive substance has a half-life of 2 years. If the initial mass is 40g, which of the following rows correctly gives the mass of substance left at the times stated?

	2Years	3year	4Years	5Years
A	20g		10g	
B	30g	20g	10g	0g
C	30g	20g	15g	
D	20g		10g	0g

47.

When a radiation strikes a metal surface, electrons maybe ejected from the metal. The maximum kinetic energy which may be acquired by an ejected electron depends on the

- A. Intensity of the radiation
B. Source of the radiation
C. Wavelength of the radiation
D. Detection device for the electron.

48.

Which of the following is TRUE of the particles emitted in radioactive disintegration?

- A. The alpha particle is the helium nucleus ${}^4_2\text{He}$
B. The alpha particle is lighter than the beta particle
C. The alpha particle is deflected more than the beta particle in a magnetic field
D. The beta particle is deflected more than alpha particle in a magnetic field.

49.

Eight alpha decays and six beta decays necessary before an atom of ${}^{238}_{92}\text{U}$ achieves stability. The final product in the chain has an atomic number of

- A. 70 B. 78
C. 82 D. 90.

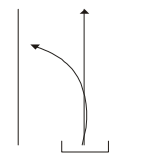

50.

A beam of radiation is passed between a pair of charged plates indicated in the diagram above. Beam P is undeflected while Q is deflected to the left. P and Q respectively could be

- I. Alphas Betas
II. x-rays Betas
III. gammas Alphas
IV. x-rays Alphas.
A. I only B. III only
C. I and II D. III and IV.

Physics 1990

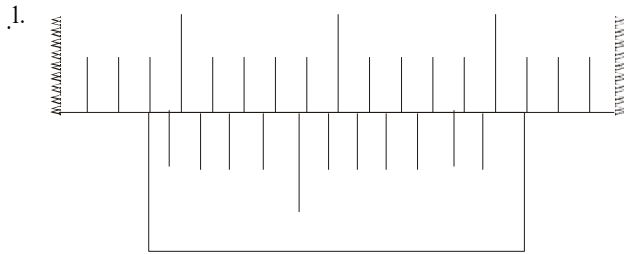

What is the reading of the vernier scale above?

- A. 1.88 cm B. 1.80 cm
C. 1.28 cm D. 1.97 mm

2. Which of the following is a fundamental unit?

- A. Newton B. Watt
C. Joule D. Second

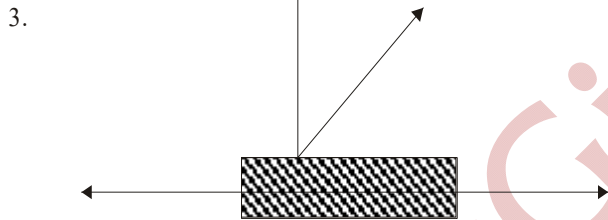

Two horizontal forces, 10N and 8N and another force F, inclined at 30° to the vertical acting as shown in the diagram above, keep the body P in equilibrium. The weight of the body is

- A. $\frac{2\sqrt{3}}{3}$ N
B. $\sqrt{3}$ N
C. $\frac{4\sqrt{3}}{3}$ N
D. $2\sqrt{3}$ N

4. A car moving with a speed of 90 km/h was brought uniformly to rest by the application of the brakes in 10 s. How far did the car travel after the brakes were applied?

- A. 125 m B. 150 m
C. 250 m D. 15 km

5. A particle of mass M which is at rest splits up into two. If the mass and velocity of one of the particles are m and v respectively, calculate the velocity of the second particle.

- A. $\frac{mv}{M}$
B. $\frac{Mv}{M-m}$
C. $\frac{Mv}{M+m}$
D. $\frac{mv}{M-m}$

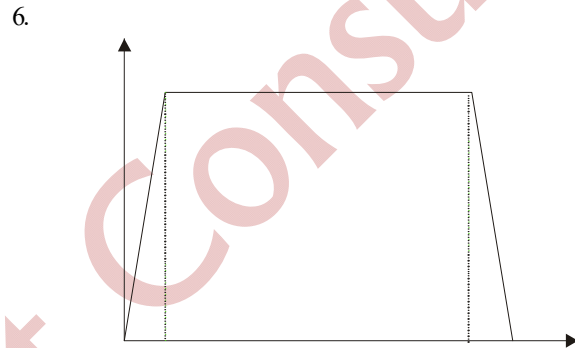

What is the average velocity of the sprinter whose velocity-time graph is shown in the figure above?

- A. 85.0 m s^{-1} B. 17.0 m s^{-1}
C. 8.5 m s^{-1} D. 1.7 m s^{-1}

7. Which of the following statements are correct about an object in equilibrium under parallel forces?

- I The total clockwise moments of the forces about any point equals the total anticlockwise moments about the same point.
II The total forces in one direction equals the total forces in the opposite direction.
III The resolved components along the x-axis equals the resolved component along the y-axis.
- A. I and II only B. I and III only
C. II and III only D. I, II and III.

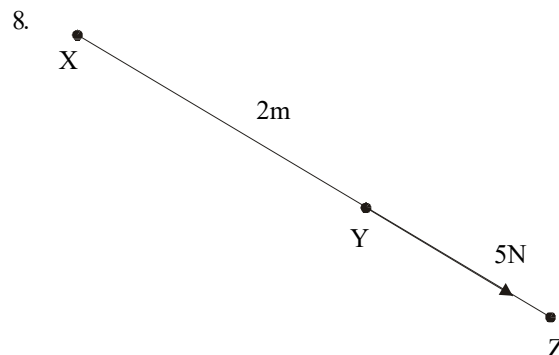

- A force of 5N acts at a point Y on a rod XYZ as shown in the diagram above. If XY is 2m, what is the moment of the force about point X?
- A. 0Nm B. 3Nm
C. 7Nm D. 10Nm.
9. To keep a vehicle moving at a constant speed v , requires power P , from the engine. The force provided by the engine is
- A. $\frac{P}{v}$ B. $1/2v$
C. pv D. p/v^2
D. $\frac{P}{v^2}$
10. A stone of mass m kg is held h meters above the floor for 50s. The work done in joules over the period is
- A. mh B. mgh
C. $mgh/50$ D. 0
11. A body of mass 10kg rests on a rough inclined plane whose angle of tilt θ is variable. θ is gradually increased until the body starts to slide down the plane at 30° . The coefficient of limiting friction between the body and the plane is
- A. 0.30 B. 0.50
C. 0.58 D. 0.87.
12. An inclined plane which makes an angle of 30° with the horizontal has a velocity ratio of
- A. 2 B. 1
C. 0.866 D. 0.50.
13. What is the length of the liquid column in a barometer tube that would support an atmospheric pressure of 102000 Nm^{-2} if the density of the liquid is 2600 kgm^{-3} ? [$g = 10 \text{ ms}^{-2}$].
- A. 0.75m B. 0.76m
C. 3.92m D. 39.23m.
14. 40cm^3 of liquid is mixed with 60m^3 of another liquid Q. If the density of P and Q are 1.00kg m^{-3} and 1.6kg m^{-3} respectively, what is the density of the mixture?
- A. 0.05 kg m^{-3} B. 1.25 kg m^{-3}
C. 1.30 kg m^{-3} D. 1.36 kg m^{-3}
15. The resistances of a platinum wire at the ice and steam points are 0.75 ohm and 1.05 ohm respectively. Determine the temperature at which the resistance of the wire is 0.90 ohm
- A. 43.0°C B. 50.0°C
C. 69.9°C D. 87.0°C
16. A bar of initial length l_0 is heated through a temperature change Δt to a new length l . The linear expansivity, α , of the bar is
- A. $\frac{l-l_0}{l \Delta t}$
B. $\frac{l-l_0}{l_0 \Delta t}$
C. $\frac{l_0}{l} (1 + \alpha \Delta t)$
D. $\frac{l-l_0}{l(1 + \alpha \Delta t)}$
17. The pressure of a gas when cooled at constant volume will decrease because the molecules
- A. Collide less frequently with the walls of the container.
B. Have the same average kinetic energy
C. Break up into smaller molecules
D. Decrease in number.
18. 1kg of copper is transferred quickly from boiling water to a block of ice. Calculate the mass of ice melted, neglecting heat loss.
- A. 60g B. 67g
C. 120g D. 133g
19. Which of the following conditions will make water boil at a temperature of 100°C when the atmospheric pressure is 750mm Hg?
- A. Increase the external pressure
B. Reduce the external pressure
C. Heat more rapidly at the same pressure.
D. Reduce the external pressure by a quarter.
20. Which of the following statements are correct?
- I Land and sea breezes are natural convection currents.
II Convection may occur in liquids or gases but not in solids.
III The vacuum in thermos flask prevents heat loss due to convection only.
- A. I and II only
B. II and III only
C. I and III only
D. I, II and III.
21. A light wave of frequency $5 \times 10^{14} \text{ Hz}$ moves through water which has a refractive index of $\frac{4}{3}$. Calculate the wavelength in water if the velocity of light in air is $3 \times 10^8 \text{ ms}^{-1}$
- A. $4.5 \times 10^8 \text{ m}$ B. $6.0 \times 10^8 \text{ m}$
C. $1.7 \times 10^{-7} \text{ m}$ D. $2.2 \times 10^{-7} \text{ m}$
22. A wave disturbance traveling in air enters a medium in which its velocity is less than that in air. Which of the following statements is true about the wave in the medium?
- A. Both the frequency of the wave and the wavelength are decreased.

- B. The frequency of the wave is decreased while the wavelength is increased.
- C. The frequency of the wave is unaltered while the wavelength is decreased.
- D. The frequency of the wave is decreased while the wavelength is unaltered.

23. Shadows and eclipse result from the
- A. Refraction of light
 - B. Rectilinear propagation of light
 - C. Defraction of light
 - D. Reflection of light
24. An object which is 3cm high is placed vertically 10cm in front of a concave mirror. If this object produces an image 40cm from the mirror, the height of the image is
- A. 0.75 cm
 - B. 4.00 cm
 - C. 8.00 cm
 - D. 12.00cm

25. A boy looks at the image of an object in a plane mirror. He observes two images, a main bright one and the other faint. The observed images result from
- A. Reflection only
 - B. Refraction only
 - C. Diffraction and interference
 - D. Reflection and infraction.

26. Which of the following diagrams correctly illustrates the path of a ray light through a glass prism?

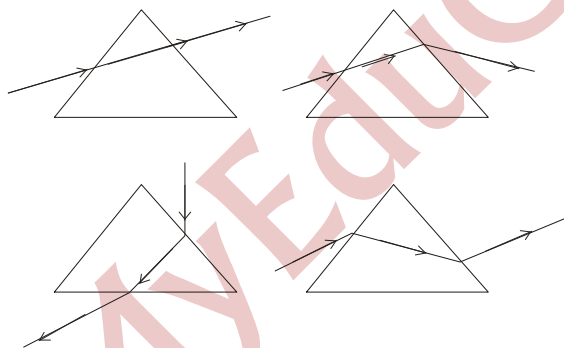

27. What must be the distance between an object and a converging lens of focal length 20cm to produce an erect image two times the object height?
- A. 20cm
 - B. 15cm
 - C. 10cm
 - D. 5cm

28. Which of the following correctly represents the diagram for locating the image P of an object O in a lens if F is the focal point of the lens?

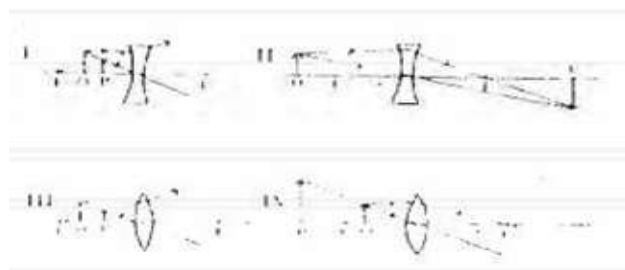

- A. I and II only
- B. II and III only
- C. III and IV only
- D. I and IV only

29. For a short sighted person, light rays from a point on a very distant object is focused
- A. In front of the retina
 - B. On the retina by a converging lens
 - C. Behind the retina by a diverging lens
 - D. In front of the retina a distance 2F from the lens.

30. When light is incident on an object which is magenta in colour, which of the following colours be absorbed?
- A. Red and blue
 - B. Green only
 - C. Red and green
 - D. Red only.

31. In a resonance tube experiment, the effective length of the air column for the first resonance is 20cm when set into vibration by a tuning fork of frequency 480 Hz. Neglecting end effect, the velocity of sound in air is
- A. 106Hz
 - B. 213Hz
 - C. 318Hz
 - D. 425Hz

33. An organ pipe closed at one end is 80cm long. Determine the frequency of the fundamental note assuming that the speed of sound in air is 340ms^{-1} .
- A. 5.1N
 - B. 7.1N
 - C. 14.0N
 - D. 19.6N

34. One of the properties of the earth's magnetic field is that the
- A. North pole lies in the northern hemisphere
 - B. Geographic and magnetic meridians coincide
 - C. Earth's magnetic flux is entirely horizontal at a place where the magnetic vertical dip is zero.
 - D. Earth's magnetic flux is entirely vertical at a place where the magnetic dip is zero.

35. Which of the following statements are true of an insulated charged body carrying a positive charge?
- I It contains excess positive charges
 - II It creates an electric field
 - III It possesses potential energy
 - IV It carries electric current.

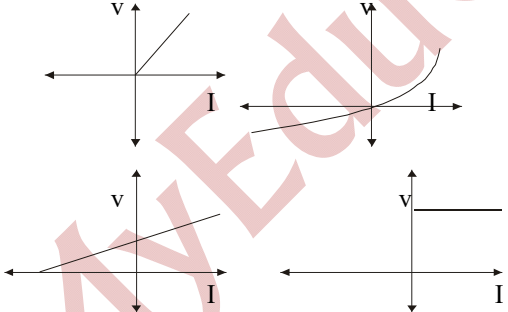
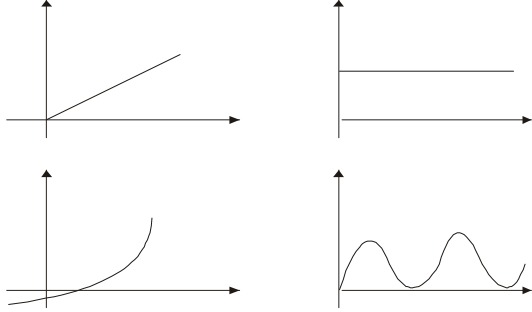
- A. I and IV only B. I and II only
C. I, II and III only D. I, II, III and IV.
36. Which of the following is a vector?
A. Electric charge
B. Electric field
C. Electric potential difference
D. Electric capacitance.
37. Three cells each of e.m.f. 1.5V and an internal resistance of 1.0 Ohms are connected in parallel across a load resistance at 2.67 Ohms. Calculate the current in the load?
A. 0.26A B. 0.41A
C. 0.50A D. 0.79A.
38. When a known standard resistor of 2.0 Ohms is connected to the 9.0cm end of a meter bridge the balance point is found to be 55.0cm. what is the value of the unknown resistor?
A. 1.10 Ohms B. 1.64 Ohms
C. 2.44 Ohms D. 27.50 Ohms
39. The total energy required to send a unit positive charge round a complete electrical circuit is the
A. Kinetic energy
B. Potential difference
C. Electromotive force
D. Electrical energy
40. Which of the following graphs of current against voltage illustrates Ohm's law?

41. Which of the following is an essential physical property of the wires used for making fuses?
A. Low density
B. High thermal conductivity
C. Low electrical resistivity
D. Low melting point.
42. Which of the following is most suitable for protecting the circuit of a 2000W electric iron connected to a 250V mains?
A. 13A B. 8A
C. 5A D. 3A
43. Electrical power is transmitted at a high voltage rather than low voltage because the amount of energy loss is reduced due to
A. Heat dissipation
B. Production of eddy currents
C. Excessive current discharged
D. Excessive voltage discharged.
44. A lamp is rated 240V, 60W. The resistance of the filament is
A. 960 Ohms B. 16 Ohms
C. 150 Ohms D. 4 Ohms
45. A 0 – 10 mA galvanometer with a coil resistance of 30 Ohms can be converted to a 0–10A ammeter by using
A. 0.03 ohms series resistor
B. 0.03 ohms shunt resistor
C. 9.99 ohms shunt resistor
D. 9.99 ohms series resistor
46. The number of neutrons contained in the nucleus of ${}_{92}^{328}\text{U}$ is
A. 92 B. 146
C. 238 D. 330
47. What precaution should a manufacturer take to ensure that energy loss in a transformer is minimized?
A. The winding of the transformer should be made of high resistance wires.
B. The core should be made of thin sheets of metal.
C. No magnetic material should be used to make the core.
D. The flux linking the primary with the secondary coils should be minimum.
48. A substance has a half life of 3 min. after 6 min, the count rate was observed to be 400. What was its count rate at zero time?
A. 200 B. 1200
C. 1600 D. 2400
49. Which of the following graphs represents a voltage current characteristics curve for a diode?

50. The photocell works on the principle of the
A. Voltaic cell
B. Emission of electrons by incident radiation
C. Emission of protons by incident electrons.

Physics 1991

- Which of the following is the most suitable for use as an altimeter?
 - A mercury barometer
 - A fortin barometer
 - A mercury manometer
 - An aneroid barometer.
- A body of weight W N rests on a smooth plane inclined at an angle Q° to the horizontal. What is the resolved part of the weight in newtons along the plane?

A. $W \sin Q$	B. $W \cos Q$
C. $W \sec Q$	D. $W \tan Q$
- A small metal ball is thrown vertically upwards from the top of a tower with an initial velocity of 20ms^{-1} . If the ball took a total of 6s to reach ground level, determine the height of the tower.

A. 60m	B. 80m
C. 100m	D. 120m
- An object moves with uniform speed round a circle. Its acceleration has
 - Constant magnitude and constant direction.
 - Constant magnitude and varying direction.
 - Varying magnitude and constant direction
 - Varying magnitude and varying direction.
- A body of mass 100g moving with a velocity of 10.0ms^{-1} collides with a wall. If after the collision, it moves with a velocity of 2.0ms^{-1} in the opposite direction, calculate the change in momentum.

A. 0.8Ns	B. 1.2Ns
C. 12.0Ns	D. 80.0Ns

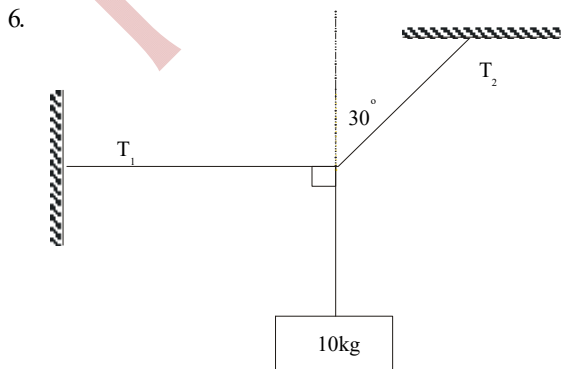

Find the tension T^1 in the diagram above if the system is in equilibrium.

- $200/\sqrt{3}$ N
- $100/\sqrt{3}$ N
- $300/\sqrt{3}$ N
- 100 N

$[g = 10\text{m s}^{-2}]$

- A spring of force constant 1500Nm^{-1} is acted upon by a constant force of 75N. Calculate the potential energy stored in the spring.

A. 1.9J	B. 3.2J
C. 3.8J	D. 5.0J
- A wheel and axle have radii 80cm and 10cm respectively. If the efficiency of the machine is 0.85, an applied force of 1200N to the wheel will raise a load of

A. 8.0 N	B. 6.8 N
C. 8160.0N	D. 9600.0N

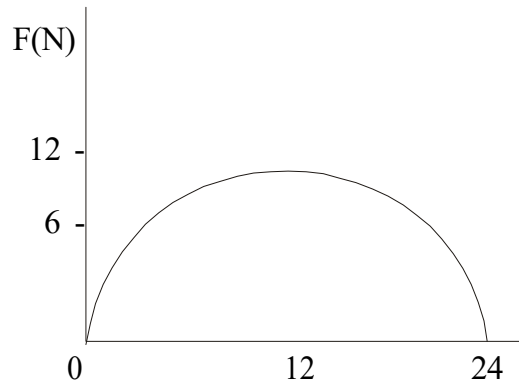

A body is under the action of a force F such that the force – displacement graph of the body is semicircular as shown above. The work done on the body by the force in moving through 24 metres is

- 36 δ J
- 72 δ J
- 144 δ J
- 288 δ J

- A 20kg mass is to be pulled up a slope inclined at 30° to the horizontal. If the efficiency of the plane is 75%, the force required to pull the load up the plane is

A. 13.3 N	B. 73.5 N
C. 133.3 N	D. 533.2 N

11. The spiral spring of a spring balance is 25.0cm long when 5N hangs on it and 30.0cm long, when the weight is 10N. What is the length of the spring if the weight is 3N assuming Hooke's Law is obeyed?
 A. 15.0cm B. 17.0cm
 C. 20.0cm D. 23.0cm
12. The mass of a stone is 15.0g when completely immersed in water and 10.0g when completely immersed in a liquid of relative density 2.0. The mass of the stone in air is
 A. 5.0g B. 12.0g
 C. 20.0g D. 25.0g
13. A pilot records the atmospheric pressure outside his plane as 63cm of Hg while a ground observer records a reading of 75cm of Hg for the atmospheric pressure on the ground. Assuming that the density of the atmosphere is constant, calculate the height of the plane above the ground. (Relative density of Hg = 13.0 and that of air = 0.00013)
 A. 1 200 m B. 6 300 m
 C. 7 500 m D. 12800m
14. In which of the following is surface tension important?
 A. The floating of a ship in water
 B. The floating of a dry needle in water
 C. The floating of a balloon in air
 D. The diffusion of a sugar solution across membrane.
15. A thermometer with an arbitrary scale, S, of equal divisions registers -30°S at the ice point and $+90^{\circ}\text{S}$ at the steam point. Calculate the Celsius temperature corresponding to 60°S .
 A. 25.0°C B. 50.0°C
 C. 66.7°C D. 75.0°C
16. A brass rod is 2m long at a certain temperature. What is the length for a temperature rise of 100K, if the expansivity of brass is $18 \times 10^{-6} \text{ K}^{-1}$?
 A. 2.0036m B. 2.0018m
 B. 2.1800m D. 2.0360m
17. What is the difference in the amount of heat given out by 4kg of steam and 4kg of water when both are cooled from 100°C to 80°C ?
 [The specific latent heat of steam is $2,260,000 \text{ J kg}^{-1}$, specific heat capacity of water is $4200 \text{ J kg}^{-1} \text{ K}^{-1}$]
 A. 4,200J B. 2,260,000J
 C. 9,040,000J D. 9,380,000J
18. The graphs below show the variation of volume (V) against temperature (T) in Kelvin for a given mass of gas at constant pressure. Which of the graphs depicts the behaviour of an ideal gas?

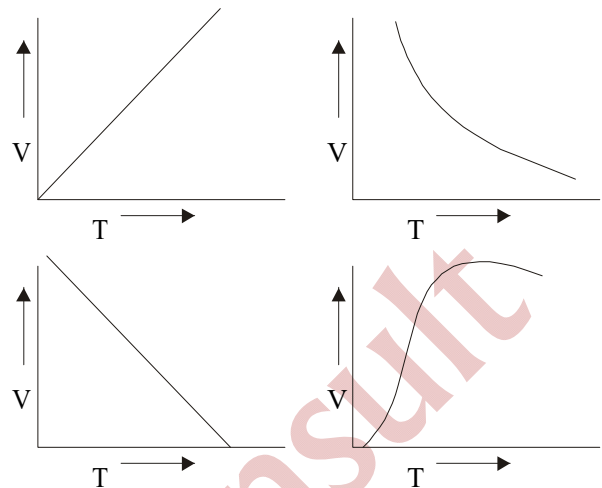

19. How long does it take a 750-W heater to rise the temperature of 1kg to water from 20°C to 50°C ?
 [Specific heat capacity of water = $4200 \text{ J kg}^{-1} \text{ K}^{-1}$]
 A. 84s B. 112s
 C. 168s D. 280s
20. The saturated vapour pressure of a liquid increases as the
 A. Volume of the liquid increases
 B. Volume of the liquid decreases
 C. Temperature of the liquid decreases
 D. Temperature of the liquid increases
21. The absolute temperature of a perfect gas is proportional to the average
 A. Potential energy of the molecules
 B. Separation between the molecules
 C. Kinetic energy of the molecules
 D. Velocity of the molecules.
22. A room is heated by means of a charcoal fire. An occupant of the room standing away from the fire is warmed mainly by
 A. Convection B. Radiation
 C. Conduction D. Reflection
23. A boy timed 30 oscillations of a certain pendulum thrice and obtained 1 min. 10s, 1min. 12s and 1 min. 7s respectively. The mean period of oscillation of the pendulum is
 A. 0.14s B. 0.43s
 C. 2.32s D. 6.97s
24. Which of the following is *TRUE* of light and sound waves?
 A. They both transmit energy
 B. They both need a medium for propagation
 C. They are both transverse waves
 D. Their velocities in air are equal.

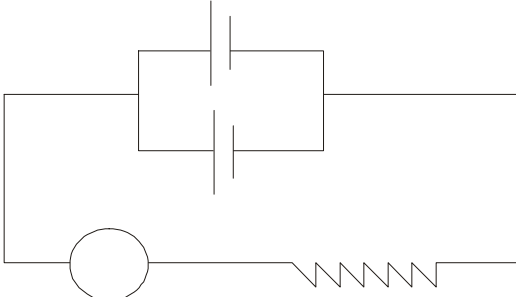
25. The image in pin-hole camera is
 A. Erect and formed by refraction through a lens
 B. Virtual and formed by dispersion
 C. Erect and gets sharper as the hole becomes larger
 D. Inverted and formed by the light from each point traveling in a straight line.
26. When a plane mirror at which a ray is incident is rotated through an angle Q , the reflected ray will be rotated through
 A. $\frac{1}{2}Q$ B. Q
 C. $2Q$ D. $3Q$
27. A trough 12.0cm deep is filled with water of refractive index $\frac{4}{3}$. By how much would a coin at the bottom of the trough appear to be displaced when viewed vertically from above the water surface?
 A. 3.0cm B. 6.0cm
 C. 9.0cm D. 16.0cm
28. In a ray diagram for a thin converging lens, a ray that is not parallel to the optic axis but passes through the optic center will
 A. Pass through undeviated
 B. Pass through the center of curvature after refraction
 C. Emerge parallel to the principal axis
 D. Pass through the principal focus after refraction.
29. Which of the following correctly describes the image of an object, 4cm from a diverging lens of focal length -12cm ?
 A. The image is virtual, 3cm in front of the lens
 B. The image is real, 6cm behind the lens
 C. The image is virtual, 6cm in front of the lens
 D. The image is real, 3cm in front of the lens.
30. Two tuning forks of frequencies 256Hz and 260 Hz are sounded close to each other. What is the frequency of the beats produced?
 A. 2 Hz
 B. 4 Hz
 C. 8 Hz
 D. 258Hz
31. A man hears his echo from a nearby hill 2s after he shouted. If the frequency of his voice is 260 Hz and the wavelength is 1.29m, how far away is the hill?
 A. 330.0m B. 335.4m
 C. 660.0m D. 670.8m
32. When the bottom tip of a vibrating tuning fork held in contact with a wooden box, a louder sound is heard. This phenomena is known as
 A. Beats
 B. Echoing
 C. Resonance
 D. Reverberation
33. Which of the following statements is *CORRECT* about the earth's magnetic field?
 A. The angle of dip is the angle which a free suspended magnet makes with the vertical
 B. The angle of declination is the angle between the magnetic meridian and the geographic meridian
 C. The angle of declination is the angle which a magnetic compass makes with the magnetic meridian.
 D. The angle of inclination is the difference between the angle of dip and the angle of declination.
34. An insulated rod when rubbed with a material acquires
 A. A negative charge if it is made of glass and rubbed with silk
 B. No charge if it is made of glass and rubbed with fur
 C. No charge if it is made of copper and rubbed with silk
 D. A positive charge if it is made of copper and rubbed with fur.
35. 
 The internal resistance of each of the cells E_1 and E_2 shown in the figure above is 2Ω . Calculate the total current in the circuit
 A. 0.80A B. 0.50A
 C. 0.40A D. 0.004A
36. The function of the system of granulated carbon mixed with manganese (IV) oxide in a Leclanche cell is to
 A. Increase the e.m.f. of the cell to 2.0V
 B. Prevent local action in the cell
 C. Prevent polarization in the cell
 D. Make the cell black and hence a good radiator

37. A moving coil galvanometer of 300 Ohms resistance gives full scale deflection for 1.0mA. The resistance, R, of the shunt that is required to convert the galvanometer into a 3.0A ammeter is
- 899.70Ohms
 - 10.00 Ohms
 - 0.10 Ohms
 - 0.01 Ohms

38. Which of the following obeys Ohm's Law?
- Glass
 - Diode
 - All electrolytes
 - All metals.

39.

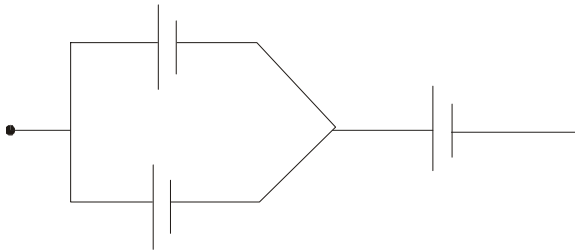

The net capacitance in the circuit shown above is

- 8.0 uF
- 6.0 uF
- 4.0 uF
- 2.0 uF

40.



In the above circuit, the fuse wire melts when

- K is opened
 - K is closed
 - The 14 – Ohms resistor is doubled with K closed
 - The 6 – Ohms resistor is doubled with K closed.
41. An equipment whose power is 1500W and resistance is 375 ohms would draw a current of
- 0.10A
 - 2.00A
 - 4.00A
 - 77.5A.
42. To convert an alternating current dynamo into a direct current dynamo, the
- Number of turns in the coil is increased
 - Strength of the field magnetic is increased
 - Slip rings are replaced with a split ring commutator
 - Coil is wound on a soft iron armature.

43. If a current carrying coil is mounted on a metal frame, the back e.m.f. induced in the coil causes
- Inductance
 - Eddy currents
 - Electromagnetism
 - Dipole moment

44. The electrochemical equivalent of platinum is $5.0 \times 10^{-7} \text{ kg C}^{-1}$. To plate-out 1.0kg of platinum, a current of 100A must be passed through an appropriate vessel for
- 5.6 hours
 - 56 hours
 - 1.4×10^4 hours
 - 2.0×10^4 hours.

45. Which of the following statements are TRUE of isotopes?

- Isotopes of an element have the same chemical properties because they have the same number of electrons.
- Isotopes of elements are normally separated using physical properties
- Isotopes of an element have the same number of protons in the nuclei.

- I and II only
- I and III only
- II and III only
- I, II and III.

46. When an atom loses or gains a charge, it becomes

- An electron
- An ion
- A neutron
- A proton.

47. 4g of a radioactive material of half-life 10 days is spilled on a laboratory floor. How long would it take to disintegrate 3.5g of the material?

- $1\frac{1}{4}$ days
- $8\frac{3}{4}$ days
- 30 days
- 80 days.

48. In a nuclear fusion process, four protons each of mass M_p were fused to produce a nucleus X of mass M_x . Which of the following equations is CORRECT?

- $4 M_p > M_x$
- $4 M_p = M_x$
- $4 M_p < M_x$
- $M_p = M_x$

49. Which of the following are TRUE for α -decay

- Mass number decreases by four
- Atomic number decreases by two
- Mass number does not change.

- I and II only
- II and III only
- I and III only
- I, II and III.

50. Which of the following phenomena is called photoelectric effect?
- A. High energy electrons impinge on a metallic anode which then emits photons
 B. A high energy photon emits photons as it is slowed down
 C. A metal absorbs quanta of light and then emits electrons
 D. Two electrons are created from quantum of light.

Physics 1992

1. What is the least possible error in using rule graduated in centimeters?
- A. 0.1cm B. 0.5cm
 C. 1.0cm D. 2.0cm
2. Which of the following affects the period of a simple pendulum?
- I Mass of the pendulum bob
 II Length of the pendulum
 III Acceleration due to gravity.
- A. I, II and III
 B. II and III only
 C. I and III only
 D. I and II only.
3. A boy sits in a train moving with uniform speed on a straight track. If from his outstretched palm he gently tosses a coin vertically upwards, the coin will fall
- A. In front of his palm
 B. Behind his palm
 C. Beside his palm
 D. Into his palm
4. A body starts from rest and moves with uniform acceleration of 6 ms^{-2} . What distance does it cover in the third second?
- A. 15m B. 18m
 C. 27m D. 30m
5. A stone, Q is thrown with velocity u at an angle of 75° to the horizontal. Another stone R is thrown with the same velocity u but at an angle of 15° to the horizontal. The ranges covered by the stones will be
- A. Greater for Q B. Greater for R
 C. The same for Q and R
 D. Greater for heavier of the stones
6. A man weighting 800N climbs up a flight of stairs to a height of 15m in 12.5s. What is the man's average power output?
- A. 667W B. 810W
 C. 960W D. 15 000W

7.

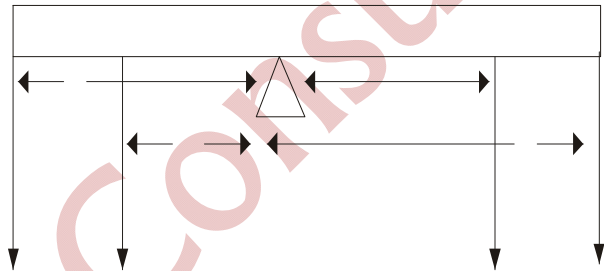

A uniform light rod is kept in horizontal equilibrium under the influence of four forces as shown above. Which of the following equations correctly represents the condition of equilibrium for the rod?

- A. $F_1 + F_2 = F_3 + F_4$
 B. $F_1 + F_2 - F_3 + F_4 = 0$
 C. $(F_1 + F_2) \times a = (F_3 + F_4) \times d = 0$
1 2 3 4

8.

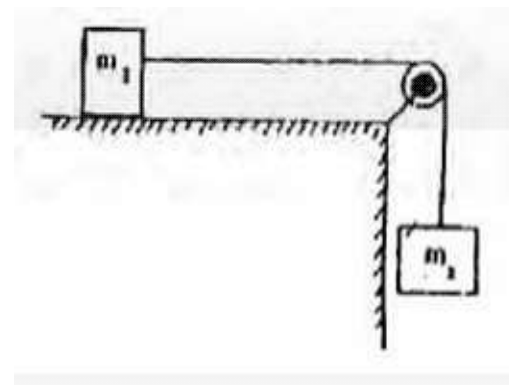

In the diagram above, the hanging mass m_2 is adjusted until m_1 is on the verge of sliding. The coefficient of static friction between the mass m_1 and the table is

- A. $\frac{m_1}{m_2}$

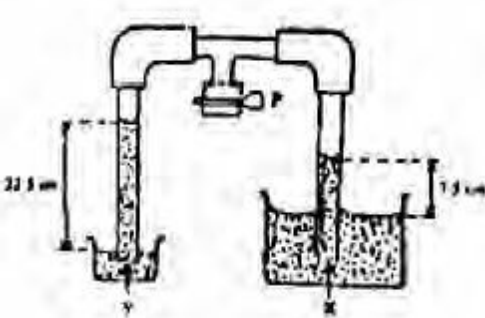
- B. $\frac{m_1 g}{m_s}$
 C. $\frac{m_2}{m_1}$
 D. $\frac{m_3 g}{m_1}$
9. A machine requires 1000J of work to raise a load of 500N through a vertical distance of 1.5m. Calculate the efficiency of the machine.
 A. 80% B. 75%
 C. 50% D. 33%
10. In an experiment to determine Young's Modulus for a wire, several loads are attached to the wire and the corresponding extensions measured. The tensile stress in each case depends on the
 A. Load and the extension
 B. Load and the radius of the wire
 C. Radius of the wire and the extension
 D. Extension and the original length of the wire.
11. 
 The figure above shows the height of two liquids X and Y when some air is sucked out of the apparatus through the pump P. the diameter of the tube in X is twice that of the Y. What is the relative density of the liquid X with respect to liquid Y?
 A. 1/3 B. 2/3
 C. 3 D. 6
12. If a plastic sphere floats in water (density = 1000kg m⁻³) with 0.5 of its volume submerged and floats in oil with 0.4 volume submerged, the density of the oil is
 A. 800 kg m⁻³ B. 1 200 kg m⁻³
 C. 1 250 kg m⁻³ D. 2 000 kg m⁻³
13. A platinum resistance thermometer wire has a resistance of 5 ohms at 0°C and 5.5 ohms at 100. Calculate the temperature of the wire when the resistance is 5.2 ohms
 A. 80°C B. 60°C
 C. 40°C D. 10°C
14. A bridge made of steel is 600m long. What is the daily variation in its length if the night-time and day-time temperatures are 10°C and 35°C respectively. The linear expansivity of steel is 0.000012 C⁻¹.
 A. 0.18cm B. 1.80cm
 C. 18.00cm D. 1800cm
15. One of the most important applications of bimetallic strip is found in the construction of
 A. A thermostat B. An altimeter
 C. A thermocouple D. A hygrometer
16. At constant pressure, the density of a fixed mass of gas is
 A. Constant with temperature
 B. Proportional to its volume
 C. Inversely proportional to its temperature
 D. Independent of its volume
17. How much heat is absorbed when a block of copper of mass 0.05kg and specific heat capacity 390J kg⁻¹ K⁻¹ is heated from 20°C to 70°C?
 A. 3.98 x 10⁻¹J B. 9.75 x 10²J
 C. 3.98 x 10³J D. 9.75 x 10³J
18. A block of ice floats on water inside a container. If the block of ice gets completely melted, the level of water in the container will
 A. Increase
 B. Remain the same
 C. Decrease
 D. First decrease and then increase.
19. The space between the double glass walls of a thermos flask is evacuated and the two surfaces facing the evacuated space are silvered. The residual source of heat loss takes place by
 A. Convection
 B. Radiation from the surfaces
 C. Conduction through the stopper and the glass.
 D. Conduction across the walls.
20. The equation of wave is
 $y = 0.005 \sin [x(0.5x - 200t)]$
 where x and y are in metres and t is in seconds. What is the velocity of the wave?
 A. 4 000 m s⁻¹ B. 400 m s⁻¹
 C. 250 m s⁻¹ D. 40 m s⁻¹
21. Which of the following characteristics of a wave is used in the measurement of the depth of the sea?
 A. Diffraction B. Interference
 C. Refraction D. Reflection

22. A note is the octave of another note if it has
 A. A frequency twice that of the first note
 B. Frequency half that of the first note
 C. The same frequency as the first one
 D. A frequency eight times that of the first note.

23. What is the frequency of the sound made by a siren having a disc with 32 holes and making 25 revolutions per second?
 A. 80 Hz B. 600 Hz
 C. 800 Hz D. 1 600 Hz

24. Which of the following properties make the convex mirror useful as a driving mirror?
 I The image is real
 II The image is erect
 III It has a wide field of view
 IV The image is magnified
 A. I, II and IV B. I, II and III
 C. II and III D. I and III.

25. When an object is placed very close to the pole of a concave mirror, the virtual image obtained is
 A. Diminished and upright
 B. Diminished and inverted
 C. Enlarged and inverted
 D. Enlarged and upright.

26. A concave mirror has a radius of curvature of 36cm. At what distance from the mirror should an object be placed to give a real image three times the size of the object?
 A. 12 cm B. 24 cm
 C. 48 cm D. 108 cm

27. Which of the following statements is *CORRECT* about a long-sighted boy who does not put on glasses?
 A. He cannot see distance objects clearly
 B. Rays of light from a close objects are focused in front of his retina
 C. His eyeball is too long
 D. Parallel rays of light are focused behind his retina.

28. The speed of light in air is $3 \times 10^8 \text{ m s}^{-1}$. What is the speed in glass with a refractive index of 1.50?
 A. $1.5 \times 10^8 \text{ m s}^{-1}$ B. $3.0 \times 10^8 \text{ m s}^{-1}$
 C. $2.0 \times 10^8 \text{ m s}^{-1}$ D. $6.0 \times 10^8 \text{ m s}^{-1}$.

29. If the refractive index of a medium in air is 2.0, what is the critical angle for this medium?
 A. 30° B. 42°
 C. 45° D. 50°

30. Which of the following arrangements of the components of electromagnetic spectrum is in ascending order of wavelengths?
 A. Gamma rays, ultraviolet rays, x-rays, infra-red rays.
 B. Gamma rays, x-rays, ultraviolet rays, infra-red rays
 C. Infra-red rays, ultraviolet rays, x-rays, gamma rays.
 D. Gamma rays, ultraviolet rays, infra-red rays, x-rays.

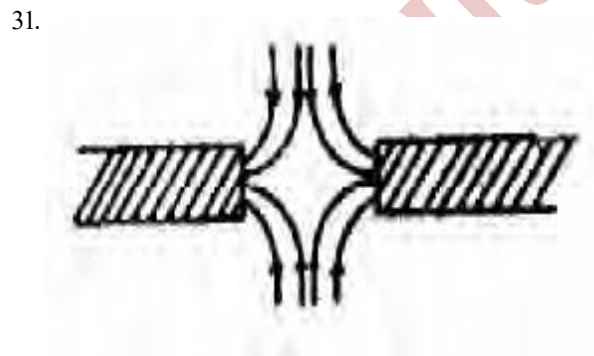

The diagram above represents the field pattern obtained by bringing the poles of two magnets near each other. The poles must be

- A. N – N poles B. S – S poles
 C. S – N poles D. N – S poles

32. The angle between the direction of the earth's magnetic field and the horizontal is called the
 A. Angle of deviation
 B. Magnetic declination
 C. Magnetic meridian
 D. Angle of dip

33. Calculate the force acting on an electron of charge $1.6 \times 10^{-19} \text{ C}$ placed in an electric field of intensity 10^8 V m^{-1} .
 A. $1.6 \times 10^{-11} \text{ N}$ B. $1.6 \times 10^{-14} \text{ N}$
 C. $1.6 \times 10^{-16} \text{ N}$ D. $1.0 \times 10^{-16} \text{ N}$

34. When an ebonite rod is rubbed with fur, it has
 A. No charge at all
 B. A negative charge
 C. A positive charge
 D. Negative and positive charges.

35. Which of the following factors has no effect on e.m.f. of a primary cell?
 A. Temperature
 B. Size of the cell
 C. Nature of the plates
 D. Nature of the electrolyte.

36. A wire of length 15m made of a material of resistivity 1.8×10^{-6} ohms-m has a resistance of 0.27 ohms. Determine the area of the wire
- A. $1.5 \times 10^{-4} \text{ m}^2$ B. $1.0 \times 10^{-4} \text{ m}^2$
 C. $2.7 \times 10^{-5} \text{ m}^2$ D. $7.3 \times 10^{-5} \text{ m}^2$

37. The diagram above shows a meter bridge in which two of the arms contain resistances R and 2 ohms. A balance point is obtained at 60cm from the left end. Calculate the value of R.
- A. 1.2 Ohms B. 1.3 Ohms
 C. 3.0 Ohms D. 6.0 Ohms

38.

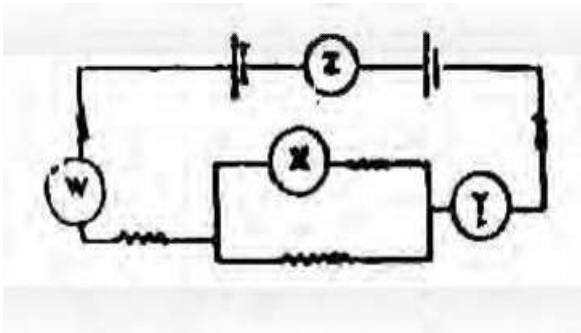

The circuit diagram above contains four ammeter W, X, Y and Z. Which of the following statements about the ammeter reading is correct?

- A. The reading of W is equal to that of Y and twice that of X.
 B. The reading of Y is greater than that of Z
 C. The readings of W and Y are equal and each is greater than that of X.
 D. The reading of Z is equal to the sum of the readings of W and Y.
39. A 5-V battery is connected across the plates of a $2.0 \mu\text{F}$ unchanged parallel plate capacitor. The charge on the capacitor after a long time is
- A. $1.5 \mu\text{C}$ B. $10.0 \mu\text{C}$
 C. $20.0 \mu\text{C}$ D. $50.0 \mu\text{C}$
40. Which of the following apparatus will require the smallest fuse rating for its protection?
- A. 60W, 240V B. 60W, 40V
 C. 40W, 12V D. 40W, 5V

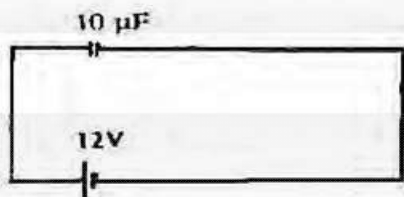

41. A capacitor of $10 \mu\text{F}$ is connected across a cell of

12 volts as shown above. Calculate the energy stored in the capacitor.

- A. $7.2 \times 10^{-4} \text{ J}$ B. $1.4 \times 10^{-3} \text{ J}$
 C. $1.4 \times 10^{-4} \text{ J}$ D. $1.3 \times 10^{-2} \text{ J}$

42. The heat produced in a conductor carrying an electric is

- A. Inversely proportional to the current and the resistance
 B. Directly proportional to the current, resistance and the time.
 C. Inversely proportional to the square of the resistance, current and the time.
 D. Directly proportional to the square of the current, the resistance and the time.

43.

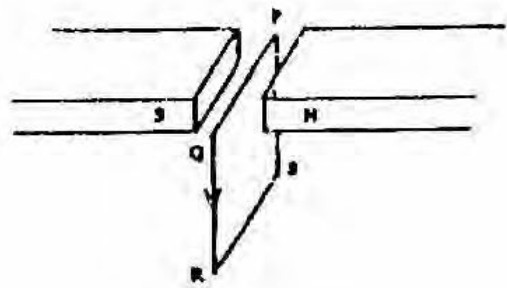

PQRS is a rectangular coil with PQ perpendicular to the magnetic field as shown in the diagram. If a current flows in the direction PQRS, in what direction will the coil move?

- a. Upwards
 b. Downwards
 c. Towards the north pole
 d. Towards the south pole.
44. The maximum permissible current through a galvanometer G of internal resistance 10Ω is 0.05A. A resistance R is used to convert G into a voltmeter with a maximum reading of 100V. Find the value of R and how it is connected to G.
- A. 20,000 ohms in parallel
 B. 19,990 ohms in series
 C. 1,990 ohms in series
 D. 100 ohms in series
45. In alternating current theory, the units of impedance, r.m.s. voltage and resonance frequency are respectively equal to
- A. Volt, ampere and hertz
 B. Ohm, volt and hertz
 C. Watt, ohm and radian
 D. Ohm, hertz and joule.

46. In A.C. circuit theory, the root mean square (r.m.s.) current, I_{rms} , and the peak (maximum) current I_0 are

related by

- A. $I_0 = I_{\text{rms}} / \sqrt{2}$
 B. $I_{\text{rms}} = I_0 / \sqrt{2}$
 C. $I_{\text{rms}} = I_0 \sqrt{2}$
 D. $I_0 = I_{\text{rms}} \sqrt{2}$

47. Which of the following graphs correctly illustrates the number of remaining atoms during a radioactive decay.

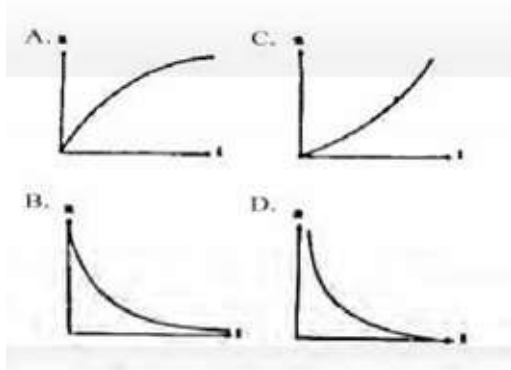

48. The threshold frequency for photoelectric effect depends on the

- A. Intensity of incident light
 B. Frequency of incident light
 C. Material of the photocathode
 D. Potential difference between the cathode and the anode

49. After three half life, the fraction of a radioactive material that has decayed is

- A. 1/8 B. 1/3
 C. 2/3 D. 7/8

50. ${}_{13}^{27}\text{Al} + {}_0^1\text{n} \rightarrow {}_{11}^{24}\text{Na} + \text{X}$
 In the nuclear reaction above, the product denoted by X is

- A. A proton
 B. A gamma ray
 C. A helium particle
 D. An alpha particle.

Physics 1993

1. Which of the following quantities has the same unit as the watt?
 A. Force x time
 B. Force x distance
 C. Force x acceleration
 D. Force x velocity

2. The external and internal diameters of a tube are measured as $(32 \pm 2)\text{mm}$ and $(21 \pm 1)\text{mm}$ respectively. Determine the percentage error in the thickness of the tube.
 A. 27% B. 14%
 C. 9% D. 3%

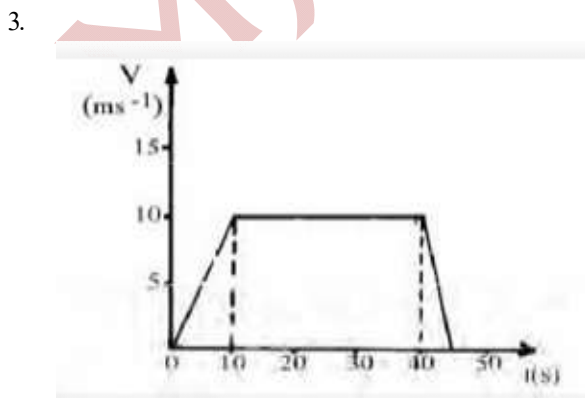

The diagram above shows a velocity–time graph representing the motion of a car. Find the total

distance covered during the acceleration and the retardation periods of the motion.

- A. 75m B. 150m
 C. 300m D. 375m

4. Two forces of magnitudes 7N and 3N act at right angles to each other. The angle θ between the resultant and the 7N force is given by

- A. $\cos Q = 3/7$ B. $\sin Q = 3/7$
 C. $\tan Q = 3/7$ D. $\cot Q = 3/7$

5. An aeroplane lands on a runway at a speed of 180kmh^{-1} and is brought to a stop uniformly in 30 seconds. What distance does it cover on the runway before coming to rest

- A. 360m B. 540m
 C. 750m D. 957m

6. A rocket burns fuel at the rate of 10kg s^{-1} and eject it with a velocity of $5 \times 10^3\text{m s}^{-1}$. the thrust exerted by the gas on the rocket is

- A. $2.5 \times 10^7\text{N}$ B. $5.0 \times 10^4\text{N}$
 C. $5.0 \times 10^2\text{N}$ D. $2.0 \times 10^{-3}\text{N}$

7. The force experienced by an object of mass 60.0kg in the moon's gravitational field is $1.002 \times 10^3\text{N}$. What is the intensity of the gravitational field?

- A. 0.60N kg^{-1} B. 1.67N kg^{-1}
 C. $6.12 \times 10^2\text{N kg}^{-1}$ D. 9.81ms^{-1}

8. Which of the following correctly describe the energy changes in the generation of light by a hydroelectric power station?
- Electrical \rightarrow mechanical \rightarrow potential \rightarrow light.
 - Potential \rightarrow mechanical \rightarrow electrical \rightarrow light.
 - Mechanical \rightarrow sound \rightarrow electrical \rightarrow light.
 - Kinetic \rightarrow mechanical \rightarrow electrical \rightarrow light.

9. A plane inclined at angle θ has a velocity ratio of 10 : 1. The inclination of the plane to the horizontal is given by

- $\tan Q = 1/10$
- $\cot Q = 1/10$
- $\cos Q = 1/10$
- $\sin Q = 1/10$

10. A weightless vessel of dimensions 4m x 3m x 2m is filled with a liquid of density 1000 kgm^{-3} and sealed. What is the maximum pressure this contain can exert on a flat surface?

- [$g = 10 \text{ ms}^{-2}$]
- $9 \times 10^4 \text{ Nm}^{-2}$
 - $4 \times 10^4 \text{ Nm}^{-2}$
 - $3 \times 10^4 \text{ Nm}^{-2}$
 - $2 \times 10^4 \text{ Nm}^{-2}$

11.

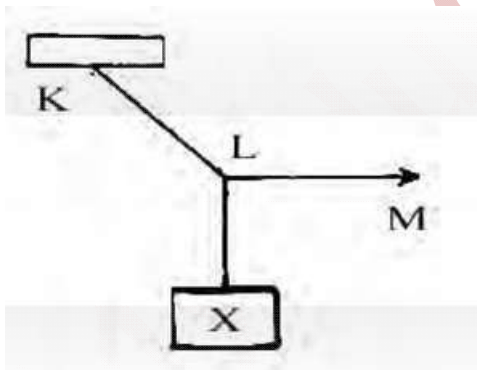

In the figure above the weight X is held in position by pulling the rope KLM in the direction LM. Which of the following diagrams shows the force acting at point L

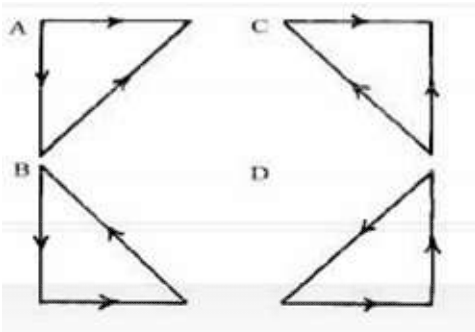

12.

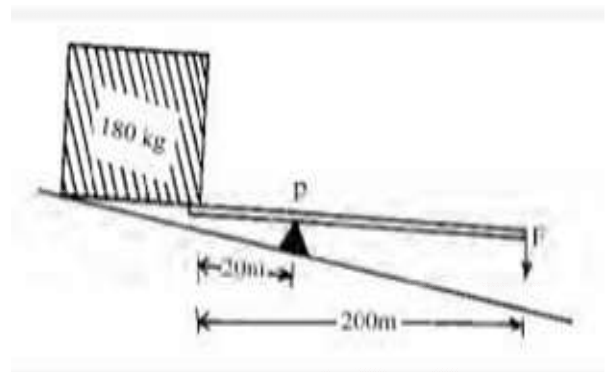

In the diagram above, a lever of length 200m is used to lift a load of mass 180kg. The pivot at P is 120m from the load. What minimum force, F , must be applied at the end of the lever?

- 9 N
- 18 N
- 20 N
- 200 N

13. An object of mass 400g and density 600 kgm^{-3} is suspended with a string so that half of it is immersed in paraffin of density 900 kgm^{-3} . The tension in the string is

- 1.0N
- 3.0N
- 4.0N
- 5.0N

14. The thermometric property of the thermocouple is that its

- e.m.f. changes with temperature
- Resistance changes with temperature
- Volume changes with temperature
- Pressure changes with resistance.

15. A metal rod 800mm long is heated from 10°C to 95°C . If it expands by .36mm, the linear expansivity of the metal is

- $2.0 \times 10^2 \text{ K}^{-1}$
- $2.0 \times 10^{-2} \text{ K}^{-1}$
- $5.0 \times 10^{-2} \text{ K}^{-1}$
- $2.0 \times 10^{-5} \text{ K}^{-1}$

16. When the volume of a given mass of gas is halved and its temperature doubled, the pressure

- Remains constant
- Increases by a factor of 4
- Increases by a factor of 3
- Decreases by a factor of 4

17. 200g of water at 90°C is mixed with 100g of water at 30°C . What is the final temperature?

- 50°C
- 60°C
- 70°C
- 80°C

18. A block of ice at 0°C is put in an open vessel and heated uniformly until half the water boils off.

Which of the following graphs best illustrates the change in temperature during the process?

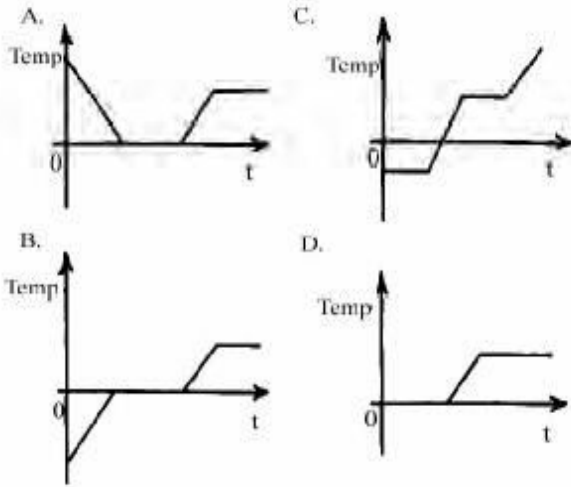

19. The melting point of a solid is given at 80°C . if 10^5J of heat energy is required at this temperature to melt 10g of the solid, the specific latent heat of fusion of the solid is
- $1.00 \times 10^3 \text{ J kg}^{-1}$
 - $1.25 \times 10^5 \text{ J kg}^{-1}$
 - $1.00 \times 10^7 \text{ J kg}^{-1}$
 - $8.00 \times 10^8 \text{ J kg}^{-1}$

Use the figure below which shows a stationary wave in a closed tube to answer questions 20 and 21.

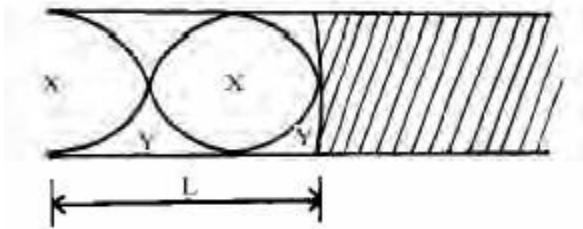

20. The relationship between L and the wavelength λ of the stationary wave is
- $2L = \lambda$
 - $L = \lambda$
 - $L = \frac{\lambda}{3}$
 - $4L = 3\lambda$
21. Determine the distance between the consecutive antinodes XX if the wavelength is 66cm .
- 15cm
 - 30cm
 - 60cm
 - 120cm
22. Which of the following waves can propagate through a vacuum?
- High velocity sound waves
 - Ultrasonic waves

- Acoustic waves
- Infra-red waves

23. Radio waves emitted from an antenna are picked up by a radar after reflection from an aircraft in $4 \times 10^{-8}\text{s}$. How far is the aircraft from the antenna? [$c = 3 \times 10^8 \text{ ms}^{-1}$]
- $6.0 \times 10^2 \text{ km}$
 - $1.2 \times 10^3 \text{ km}$
 - $3.0 \times 10^3 \text{ km}$
 - $6.0 \times 10^5 \text{ km}$
24. The fundamental frequency of vibration (f) of a wire is measured as a function of the tension (T) in the wire. Which of the following curves adequately represents the data?

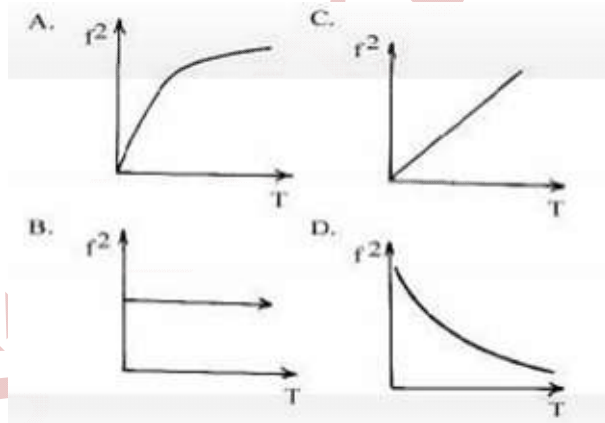

25.

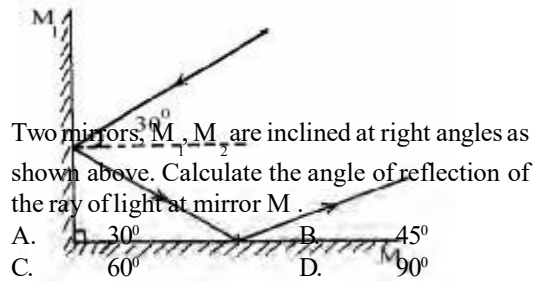

Two mirrors, M_1, M_2 are inclined at right angles as shown above. Calculate the angle of reflection of the ray of light at mirror M_1 .

- 30°
- 45°
- 60°
- 90°

26.

Which of the following expressions gives the linear magnification produced by a concave mirror of radius of curvature r , if u and v are the object and image distances respectively?

- $\frac{v}{r} - 1$
- $\frac{2v}{r} - 1$
- $\frac{u}{r} - 1$
- $\frac{2u}{r} - 1$

27. If the focal length of a camera lens is 20cm, the distance from the film at which the lens must be set to produce a sharp image of an object 100cm away is
- A. 17cm B. 20cm
C. 25cm D. 100cm
28. Which of the following may be used to explain a mirage?
- I Layers of air near the road surface have varying refractive indices in hot weather
II Road surfaces sometimes becomes good reflectors in hot weather.
III Light from the sky can be reflected upwards after coming close to the road surface.
- A. II only
B. II and III only
C. I and III only
D. I, II and III.
29. A beam of light is incident from air to, water at an angle 30° . Find the angle of refraction if the refractive index of water is $4/3$.
- A. 15° B. 18°
C. 22° D. 24°
30. The property of the eye known as its power of accommodation is controlled by the
- A. Pupil B. Vitreous humour
C. Iris D. Ciliary muscles
31. Which of the following correctly explains(s) why a green leaf appears green in bright daylight?
- I It absorbs only the green component of sunlight.
II It absorbs all colours in sunlight except green.
III It reflects only the green component of sunlight.
- A. I only
B. II only
C. I and III only
D. II and III only.
32. A field that results from the contact of a positively charged ball with the inner wall of an uncharged hollow conducting sphere is
- A. Inside the sphere
B. On the surface of the ball
C. Inside and outside the sphere
D. Outside the sphere.
33. A horizontal component of the earth's magnetic field and the magnetic field of a straight wire X carries current into the plane of a paper. Which of the following figures correctly illustrates the

resultant magnetic field pattern in the horizontal plane?

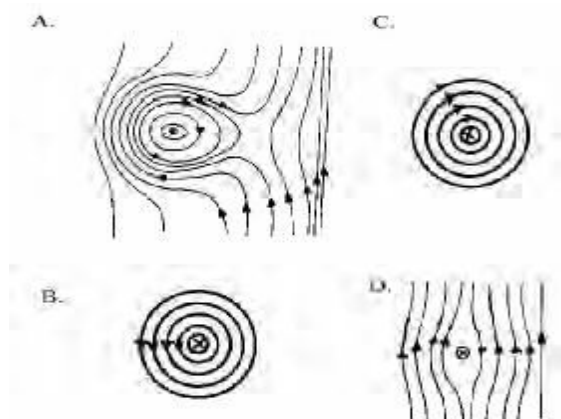

34. Which of the following correctly explain(s) why soft iron is preferred to steel in electromagnets?
- I Soft iron is more readily magnetized than steel.
II Soft iron is more readily demagnetized than steel.
III Soft iron retains magnetism more than steel.
- A. I only
B. II and III only
C. I and II only
D. I, II and III.
35. A current-carrying conductor experiences a force when placed in a magnetic field because the
- A. Conductor is magnetized
B. Magnetic field of the current interacts with external magnetic field.
C. Force is due to the motor principle
D. Electric field of the current interacts with the external magnetic field.
36. A simple cell with mercury-amalgamated zinc electrode prevents
- A. Local action B. Polarization
C. Buckling D. Degradation.
37. The terminal voltage of a battery is 4.0V when supplying a current of 2.0A, and 2.0V when supplying a current of 3.0A. The internal resistance of the battery is
- A. 0.5 Ohms
B. 1.0 Ohms
C. 2.0 Ohms
D. 4.0 Ohms

38.

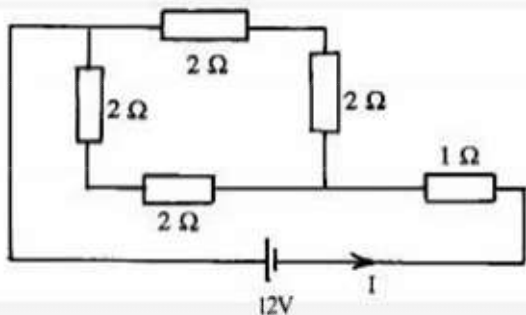

The current I in the figure above is

- A. 4.00A B. 1.30A
C. 0.80A D. 0.75A

39.

A current of 100mA passes through a conductor for 2 minutes. The quantity of electricity transported is

- A. 200C B. 50C
C. 12C D. 0.02C

40.

A parallel plate capacitor of area 10cm^2 in vacuum has a capacitance of $10^{-2}\mu\text{F}$. What is the distance between the plates?

($S_0 = 9 \times 10^{-12} \text{ Fm}$)

- A. $9 \times 10^{-13} \text{ m}$ B. $9 \times 10^7 \text{ m}$
C. $9 \times 10^{-3} \text{ m}$ D. $9 \times 10^7 \text{ m}$

41.

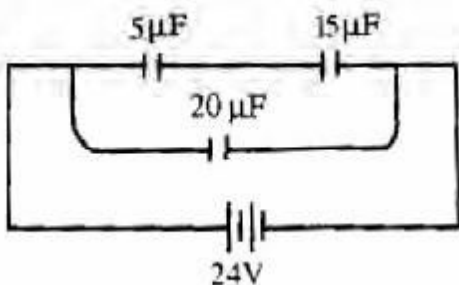

In the network shown above, determine the potential difference across the $5\mu\text{F}$ capacitor.

- A. 3V B. 6V
C. 12V D. 18V

42.

A 40-W instrument has a resistance of 90 ohms. On what voltage should it be operated normally?

- A. 60V B. 150V
C. 225V D. 3600V

43.

Which of the following devices may be used to set up the voltage in d.c. circuit?

- A. A step-up transformer
B. A d.c. generator
C. A wattmeter
D. An induction coil.

44.

The primary aim in high tension transmission is to

- A. Minimize electrical energy losses due to heat production
B. Increase the rate of energy transfer by using high voltage
C. Increase the current in the wires.
D. Generate electricity at high current and low voltage.

45.

Determine the inductive reactance when a 30.0mH inductor with a negligible resistance is connected to a $1.30 \times 10^3 \text{ Hz}$ oscillator.

- A. 39.0 Ohms
B. 122.5 Ohms
C. 245.0 Ohms
D. 39000.0 Ohms

46.

Which of the following statements correctly describe(s) cathode rays?

- I They consist of tiny particles negative electric charges
II They are deflected in a magnetic field but not in an electric field
III They consist of fast moving neutrons and deflected in an electric field.

- A. I only
B. III only
C. I and II only
D. II and III only

48.

Which of the following are produced after a nuclear fusion process?

- I One heavy nucleus
II Neutrons III Protons
IV Energy

- A. I and II B. I and IV
C. II and III D. II and IV.

49.

An element X of atomic number 88 and mass number 226 decays to form an element Z by emitting two beta particles and an alpha particles. Z is represent by

- A. ${}_{82}^{222}\text{Z}$
B. ${}_{88}^{222}\text{Z}$
C. ${}_{86}^{226}\text{Z}$
D. ${}_{80}^{226}\text{Z}$

50.

The kinetic energy of a photoelectron liberated from a metallic surface depends on the

- A. Intensity of the incident radiation
B. Time duration of the incident radiation
C. Temperature of the incident radiation
D. Frequency of the incident radiation

Physics 1994

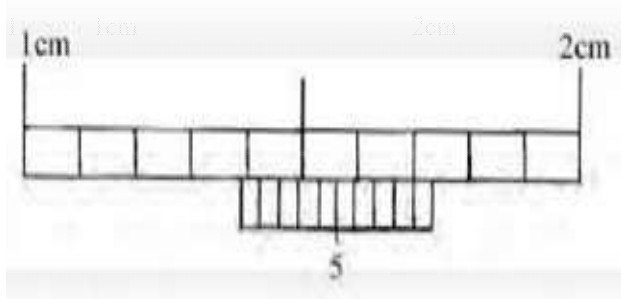

What is the reading of the vernier calipers shown above?

- A. 1.79 cm B. 1.73 cm
C. 1.39 cm D. 1.34 cm
2. If it takes 5.0 hours to drain a container of 540.0 cm³ of water, what is the flow rate of water from the container in kg s⁻¹?
- A. 32.5 B. 31.5
C. 30.8 D. 30.0

(Density of water = 100 kg m⁻³)

3. A boat travels due east at a speed of 40 ms⁻¹. What is the resultant speed of the boat?
- A. 1.3 ms⁻¹ B. 10.0 ms⁻¹
C. 50.0 ms⁻¹ D. 70.0 ms⁻¹
4. An object is projected with velocity of 80 ms⁻¹ at an angle of 30° to the horizontal. The maximum height reached is
- A. 20 m B. 80 m
C. 160 m D. 320 m

5. A motor vehicle is brought to rest from a speed of 15 ms⁻¹ in 20 seconds. Calculate the retardation.
- A. 0.75 ms⁻² B. 1.33 ms⁻²
C. 5.00 ms⁻² D. 7.50 ms⁻²

6. Which of the following is TRUE of a particle moving in a horizontal circle with constant angular velocity?
- A. The energy is constant but the linear momentum varies
B. The linear momentum is constant but the energy varies.
C. Both energy and linear momentum are constant.
D. The speed and the linear velocity are both constant.

7. A stone thrown vertically upwards returns to the ground. Which of the following figures represents the velocity-time graph?

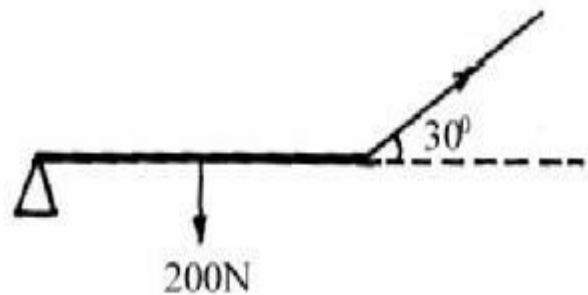
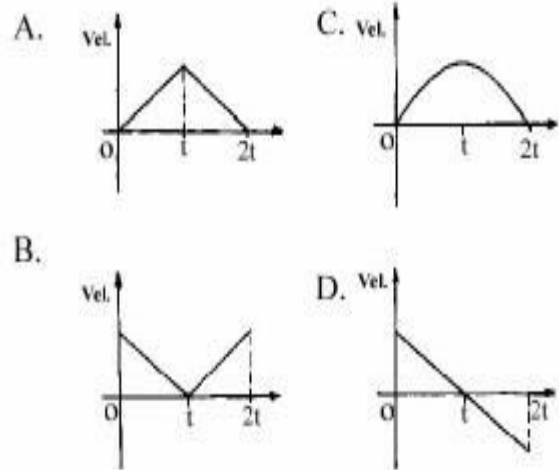

8. The diagram above shows a uniform wood of weight 200 N and length 50 m. It is pivoted at one end and suspended by a cord at the other end at an angle of 30° to the wood. Calculate the tension in the cord if the wood is horizontal.

- A. 10 N B. 20 N
C. 100 N D. 200 N

9. An object of mass 50 kg is released from a height of 2 m. Find the kinetic energy just before it strikes the ground.

- A. 250 J B. 1 000 J
C. 10 000 J D. 100 000 J

10. A cone in an unstable equilibrium has its potential energy

- A. Decreased B. Increased
C. Unchanged D. Oscillating

11. Calculate the magnitude of the force required to just move a 20 kg object along a horizontal surface if the coefficient of friction is 0.2
- A. 400.0 N B. 40.0 N
C. 4.0 N D. 0.4 N

12. Calculate the velocity ratio of a screw jack of pitch 0.3 cm if the length of the tommy bar is 21 cm.
- A. $\frac{1}{140} \pi$
B. 14π
C. 70π
D. 140π

13. Which of the following graphs correctly represents the relationship between the load and the velocity ratio of a machine?

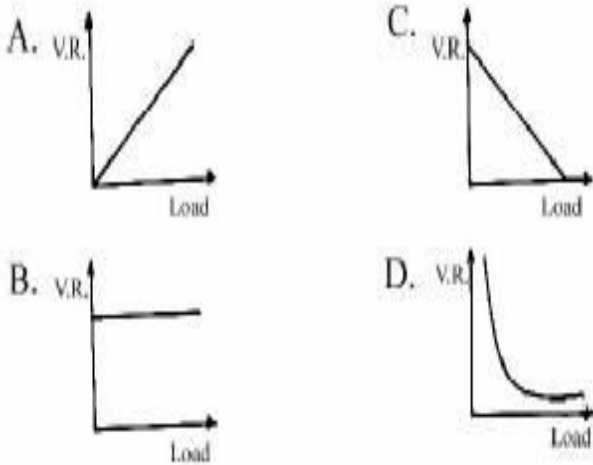

14. A spring of length 25 cm is extended to 30 cm by a load of 150 N attached to one of its ends. What is the energy stored in the spring?
- A. 3750 J B. 2500 J
C. 3.75 J D. 2.50 J

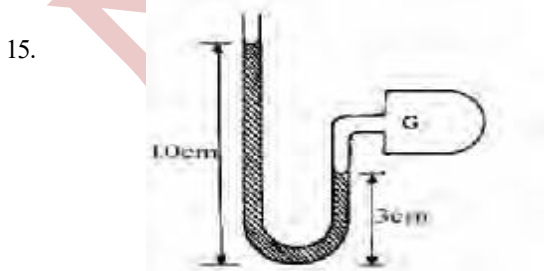

In the diagram above, if the atmospheric pressure is 760 mm, the pressure in the chamber G is

- A. 660 mm B. 690 mm
C. 830 mm D. 860 mm

16. A force of 15 N stretches a spring to a total length of 30 cm. An additional force of 10 N stretches the spring 5 cm further. Find the natural length of the spring.

- A. 25.0 cm B. 22.5 cm
C. 20.0 cm D. 15.0 cm

17. Which of these statements are TRUE of pressure in liquids?

- I Pressure acts equally in all directions.
II Pressure decreases with depth.
III Pressure at the same level of a liquid is the same.
IV Pressure is dependent on the cross-sectional area of the barometer tube.

- A. I and III only.
B. I, II and III only.
C. I, II and IV only.
D. I, II, III and IV.

18. The mass of a specific gravity bottle is 15.2 g when it is empty. It is 24.8 g when filled with kerosene and 27.2 g when filled with distilled water. Calculate the relative density of kerosene.

- A. 1.25 B. 1.10
C. 0.90 D. 0.80

19. If a solid X floats in liquid P of relative density 2.0 and in liquid Q of relative density 1.5, it can be inferred that the

- A. Weight of P displaced is greater than that of Q
B. Weight of P displaced is less than that of Q
C. Volume of P displaced is greater than that of Q
D. Volume of P displaced is less than that of Q.

20. The melting point of naphthalene is 78°C. What is this temperature in Kelvin?

- A. 100 K B. 315 K
C. 378 K D. 444 K

21. A motor tyre is inflated to pressure of $2.0 \times 10^5 \text{ Nm}^{-2}$ when the temperature of air is 27°C. What will be the pressure in it at 87°C assuming that the volume of the tyre does not change?

- A. $2.6 \times 10^5 \text{ Nm}^{-2}$ B. $2.4 \times 10^5 \text{ Nm}^{-2}$
C. $2.2 \times 10^5 \text{ Nm}^{-2}$ D. $1.3 \times 10^5 \text{ Nm}^{-2}$

22. When 100 g of liquid L_1 at 78°C was mixed Xg of liquid L_2 at 50°C , the final temperature was 66°C . Given that the specific heat capacity of L_2 is half that of L_1 , find X.
- A. 50 g B. 100 g
C. 150 g D. 200 g

23. A volume of water is heated from 0°C to 15°C . Which of the following diagrams correctly represents the variation of the volume with temperature?

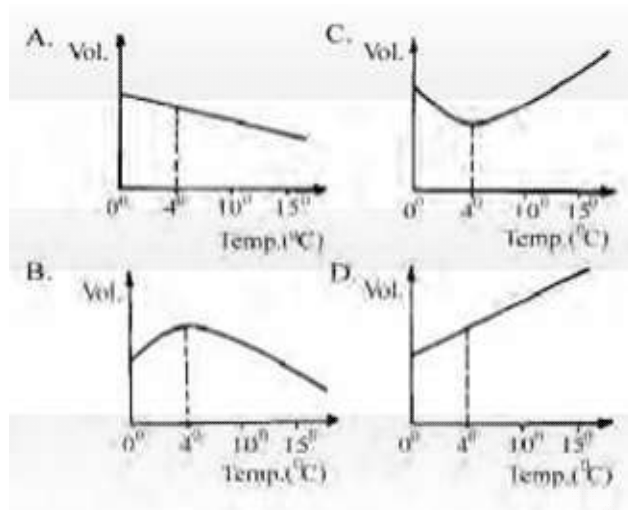

24. Heat is supplied to a test tube containing 100 g of ice at its melting point. The ice melts completely in 1 min. what is the power rating of the source of heat?
- A. 336 W B. 450 W
C. 560 W D. 600 W
- (Latent heat of fusion of ice = 336 Jg^{-1})

25. If a room is saturated with water vapour, the temperature of the room must be
- A. at 0°C
B. above the dew point
C. at 100°C
D. below or at the dew point.

26. Which of the following graphs represents the variation of pressure P against volume V at constant temperature?

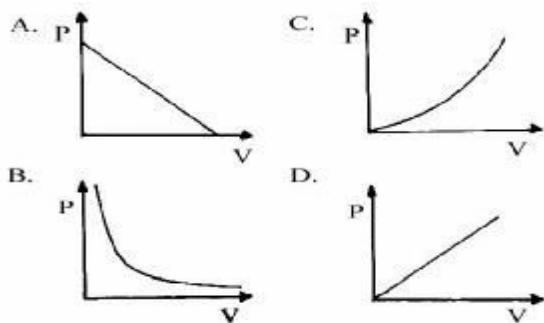

27. Two similar kettles containing equal masses of boiling water are placed on a table. If the surface of one is highly polished and the surface of the other is covered with soot, which of the following observations is correct?

28. The equation of a transverse wave traveling along a string is given by $y = 0.3 \sin(0.5x - 50t)$ where y and x are in cm and t is in seconds. Find the maximum displacement of the particles from the equilibrium position.
- A. 50.0 cm B. 2.5 cm
C. 0.5 cm D. 0.3 cm

29. The sound from a source traveled to the bottom of the sea and the echo was heard 4s latter. If the speed of sound in sea water is 1500 ms^{-1} , the depth of the sea is
- A. 6000m B. 3000m
C. 1500m D. 375 m

30. The fundamental frequency of vibration of a sonometer wire may be halved by
- A. Doubling the length of the wire
B. Doubling the mass of the wire
C. Reducing the tension by half
D. Reducing the absolute temperature by half.

31. A pipe of length 45 cm is closed at one end. Calculate the fundamental frequency of the sound wave generated in the pipe if the velocity of sound in air is 360 ms^{-1} (Neglect end corrections).
- A. 55. Hz B. 148.5 Hz
C. 200.00Hz D. 550.0 Hz

32. The note produced by a stretched string has a fundamental frequency of 400 Hz. If the length of the string is doubled while the tension in the string is increased by a factor of 4, the frequency is
- A. 200Hz B. 400Hz
C. 800Hz D. 1600Hz

33. To produce a parallel beam of light from a concave mirror, the distance at which the lamp should be placed from the mirror is equal to
- A. the focal length
B. two times the focal length
C. the distance of the image
D. two times the radius of curvature.

34. Light of frequency 6.0×10^{14} Hz traveling in air is transmitted through glass of refractive index 1.5. Calculate the frequency of the light in the glass.
- A. 4.0×10^{14} Hz
 B. 6.0×10^{14} Hz
 C. 7.5×10^{14} Hz
 D. 9.0×10^{14} Hz

35. An object is placed in front of a converging lens of focal length 200 cm. The image is virtual and has a magnification of 2. What is the distance of the object from the lens?
- A. 5 cm B. 10 cm
 C. 30 cm D. 40 cm

36. An object is placed directly below a glass block of thickness 3.0 cm. Calculate the lateral displacement of the object if the refractive index of the glass is 1.5
- A. 1.0 cm B. 1.5 cm
 C. 2.0 cm D. 2.5 cm

37. In a projection lantern of focal length f , the object distance u , is such that
- A. $u > 2f > f$
 B. $u < f < 2f$
 C. $u = f < 2f$
 D. $f < u < 2f$

38. If the Nigerian flag (green, white, green) is viewed in pure yellow light, which of the following set of colours would be observed on the flag?
- A. Green, yellow, green
 B. Red, yellow, red.
 C. Black, yellow, black.
 D. Green, white, green.

39. Which of the figures below illustrates the dispersion of white light through a triangular glass prism?

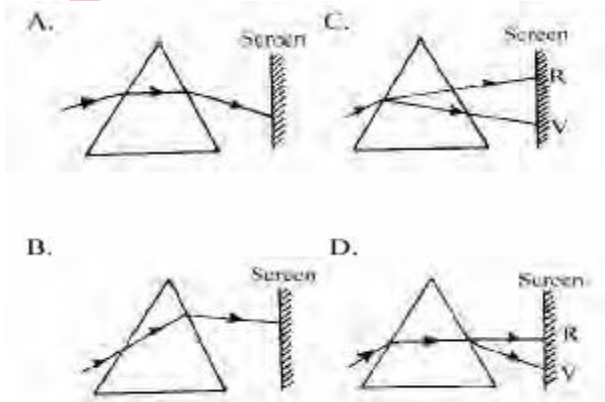

40. Which of the following has the lowest internal resistance when new?
- A. Leclanche cell. B. Daniel cell.
 C. Accumulator D. Torch battery.

41. When a biro pen rubbed on a dry silk cloth is moved very close to a piece of paper on a dry table, the pen is found to pick up the paper. This is because
- A. Both the pen and the cloth are magnetized
 B. The pen is magnetized but the cloth is not
 C. The pen is charged while the cloth is magnetized
 D. Both the pen and the cloth are charged.

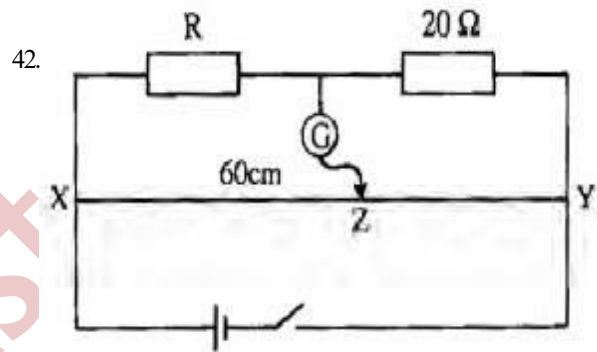

In the figure above, XY is of length 1m. The value of R at balance point Z is

- A. 3.0 Ohms
 B. 13.3 Ohms
 C. 15.0 Ohms
 D. 30.0 Ohms
43. A capacitor 8 μ F, is charged to a potential difference of 100V. The energy stored by the capacitor is
- A. 1.0×10^4 J B. 8.0×10 J
 C. 1.25×10 J D. 4.0×10^{-2} J
44. Two resistors, $R_1 = 4$ Ohms and $R_2 = 5$ Ohms, are connected in parallel across a potential difference. If P_1 and P_2 represent the power dissipated in R_1 and R_2 respectively, the ratio $P_1 : P_2$ is
- A. 4 : 5
 B. 5 : 4
 C. 16 : 25
 D. 25 : 16

45.

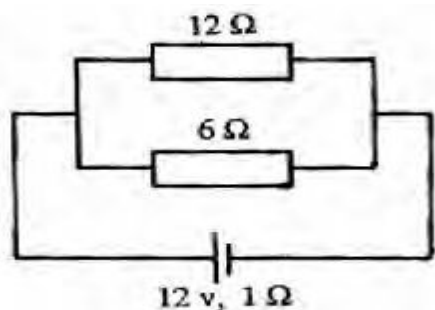

In the circuit diagram above, calculate the current in the 12 – Ohms resistor if the cell has an e.m.f. of 12V and an internal resistance of 1 ohms.

- A. 0.8A B. 1.0A
C. 1.6A D. 2.4A

46. Which of the following are found in the receiver but not in the microphone of a telephone handset?

- I Diaphragm
II Soft iron pole pieces.
III Permanent magnet.
IV Carbon blocks
- A. I and II
B. I and IV.
C. II and III
D. III and IV.

47. If two parallel conductors carry currents flowing in the same direction, the conductors will

- A. Attract each other
B. Repel each other
C. Both move in the same direction
D. Have no effect on each other.

48. A certain radioisotope of ${}^{235}_{92}\text{U}$ emits

four alpha particles and three beta particles. The mass number and the atomic number of the resulting element respectively are

- A. 219 and 87
B. 84 and 223
C. 223 and 87
D. 219 and 81

49.

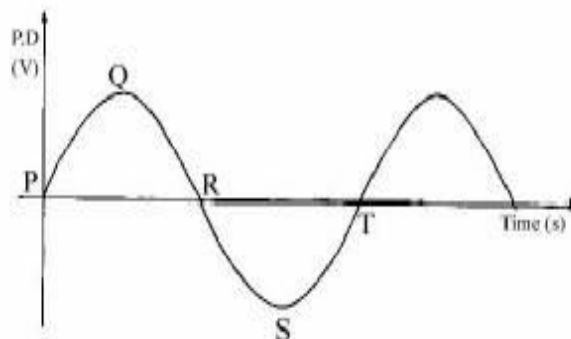

In the curve above, PQRST represents an alternating voltage frequency 50 Hz. The time interval between point P and R on the graph is

- A. 25 s
B. $\frac{1}{50}$ s
C. $\frac{1}{100}$ s
D. $\frac{1}{200}$ s

50. If the light with photon energy 2 eV is incident suitably on the surface of a metal with work function 3 eV, then

- A. No electron will be emitted
B. The few electrons emitted will have a maximum kinetic energy of 1 eV
C. The few electrons emitted will have a maximum kinetic energy of 3 eV
D. Many electrons will be emitted.

This past question was successful uploaded by Olanik Consultancy. You can also visit the site www.myedugist.com for latest information on Examination, Education and Scholarships worldwide.

Physics 1995

1. Which of the following is the dimension of pressure?

- A. $ML^{-1}T^{-2}$ B. MLT^2
 C. ML^2T^{-3} D. ML^{-3}

2. The length of a displaced pendulum bob which passes its lowest point twice every second is

- A. 0.25m B. 0.45m
 C. 0.58m D. 1.00m
 [$g = 10ms^{-2}$]

3.

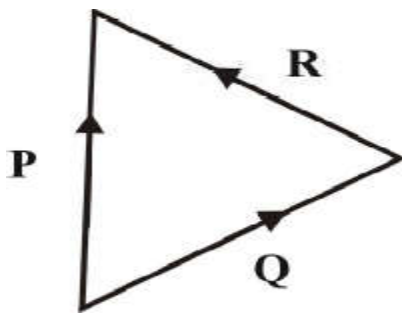

In the diagram above, P, Q and R are vectors. Which of the following options gives the correct relationship between the vectors?

- A. $P = Q + R$ B. $P = Q - R$
 C. $P = R - Q$ D. $P + Q + R = 0$

4.

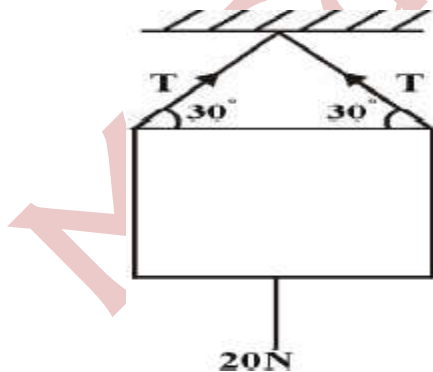

The value of T in the figure above is

- A. 10.0N B. 11.8N
 C. 20.0N D. 40.0N

5. When a ball rolls on a smooth level ground, the motion of its centre is

- A. Translational B. Oscillatory
 C. Random D. Rotational

6. The velocity-time graph of a body moving in a straight line and decelerating uniformly to rest is represented by

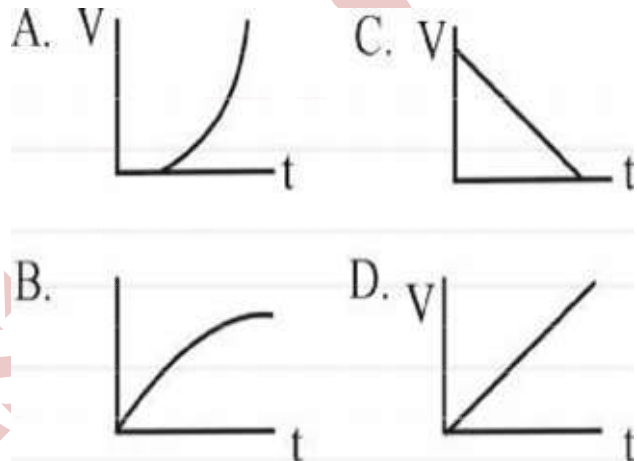

7.

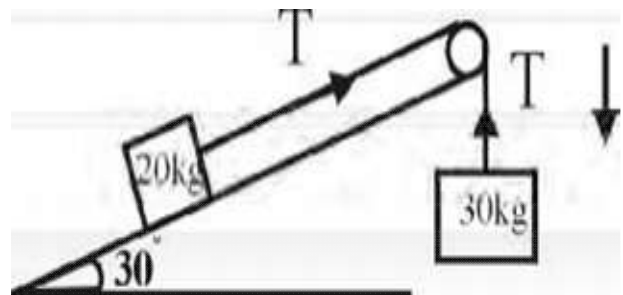

The acceleration of the system shown above is

- A. $2 ms^{-2}$ B. $4 ms^{-2}$
 C. $6 ms^{-2}$ D. $8 ms^{-2}$

8. What is the acceleration due to gravity 'g' on the moon, if g is $10ms^{-2}$ on the earth?

- A. $0.10 ms^{-2}$ B. $0.74 ms^{-2}$
 C. $1.67 ms^{-2}$ D. $10.00 ms^{-2}$

9. A body is projected from the earth's surface with the intention of letting it escape from the earth's gravitational field. What is the minimum escape velocity of the body?

- A. $14km s^{-1}$ B. $13 km s^{-1}$
 C. $12 km s^{-1}$ D. $11 km s^{-1}$

10. A uniform rod PQ of length 1m and mass 2kg is pivoted at the end P. If a load of 14N is placed at the centre of the rod, find the force that should be applied vertically upwards at Q to maintain the rod in equilibrium horizontally.
- A. 68N B. 28N
C. 17N D. 7N
- [$g = 10 \text{ ms}^{-2}$]

11. A vehicle of mass m is driven by an engine of power P from rest. Find the minimum time it will take to acquire a speed v .
- A. $\frac{mv^2}{P}$
B. $\frac{mv^2}{2P}$
C. $\frac{mv}{P}$

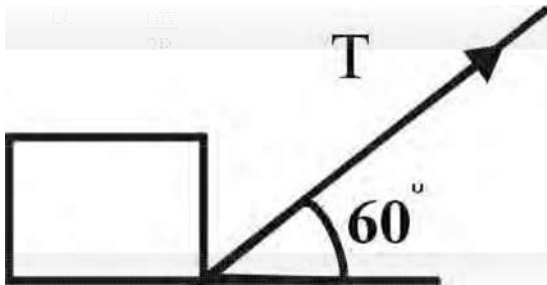

12. A box of mass 40 kg is being dragged along the floor by a rope inclined at 60° to the horizontal. The frictional force between the box and the floor is 100N and the tension on the rope is 300N. How much work is done in dragging the box through a distance of 4m?
- A. 680J B. 400J
C. 200J D. 100J

13. Which of the following statements are *TRUE* about frictional force?
- I It is always a disadvantage
II It is sometimes a disadvantage
III It always exists where there is a relative motion of two bodies that are in contact.
IV It is sometimes very useful.

14. The energy contained in a wire when it is extended by 0.02m by a force of 500 N is
- A. 5 J B. 10 J
C. 10^3 J D. 10^4 J

15. Which of the following levers has the greatest mechanical advantage?

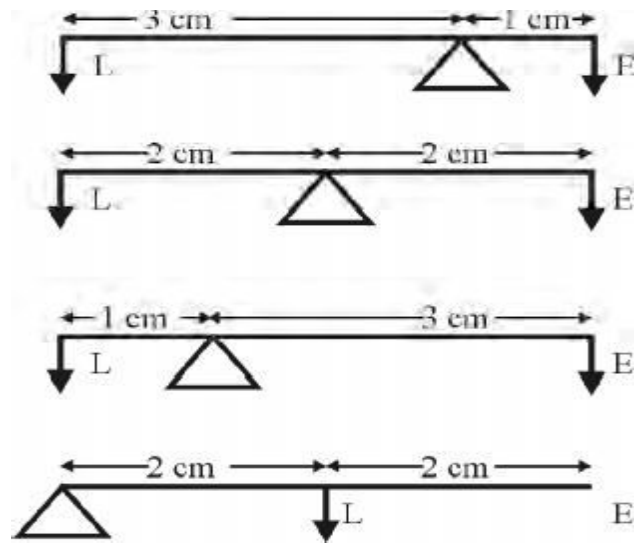

16. A hydraulic press has a large circular piston of radius 0.8m and a circular plunger of radius 0.2m. A force of 500N is exerted by the plunger. Find the force exerted on the piston.
- A. 8000 N B. 4000 N
C. 2000 N D. 31 N

17. The volume of an air bubble increases from the bottom to the top of a lake at constant temperature because
- A. Atmospheric pressure acts on the surface of the lake.
B. Pressure increases with depth of the lake.
C. Density remains constant with pressure
D. The bubble experiences an upthrust.

18. Temperature is a measure of the
- A. Quantity of heat transferred into the molecules of an object
B. Mean kinetic energy of any molecules of the object
C. Kinetic energy of any individual molecules of the substance.
D. Amount of work done by the molecules of the object.

19. A rectangular metal block of volume 10^{-6} m^3 at 573K. If its coefficient of linear expansion is $1.2 \times 10^{-5} \text{ K}^{-1}$, the percentage change of its volume is
- A. 1.5% B. 1.1%
C. 0.4% D. 0.1%

20. A piece of wood floats inside water at room temperature with a fraction of it above the liquid surface. As the temperature of the water is raised,

the part of the wood above the density of liquid will

- A. Decrease because the density of water decreases with temperature.
- B. Increases because the density of water decreases with temperature.
- C. Decreases because the density of water increases with temperature
- D. Increase because the density of water increases with temperature.

21. The equation $P^x V^y T^z = \text{constant}$ is Charles' law when

- A. $x = 1, y = -1, z = 1$
- B. $x = 0, y = 1, z = -1$
- C. $x = 1, y = 0, z = -1$
- D. $x = 0, y = 1, z = 1.$

22. An electric kettle with negligible heat capacity is rated at 2000 W. If 2.0kg of water is put in it, how long will it take the temperature of water to rise from 20°C to 100°C?

- A. 420s
 - B. 336s
 - C. 168s
 - D. 84s.
- [specific heat capacity of water = 4200 J kg⁻¹ K⁻¹].

23. A temperature scale has a lower fixed point of 40mm and an upper fixed point of 200mm. What is the reading on this scale when a thermometer read 60°C?

- A. 33.3 mm
- B. 36.0 mm
- C. 96.0 mm
- D. 136.0 mm

24. A quantity of ice at -10°C is heated until the temperature of the heating vessel is 90°C. Which of the following constant is *NOT* required to the vessel?

- A. Specific heat capacity of ice
- B. Specific heat capacity of water
- C. Specific latent heat of fusion
- D. Specific latent heat of vaporization.

25. Which of the following statements give the *TRUE* differences between evaporation and boiling

- I Evaporation occurs at all temperatures while boiling occurs at a fixed temperature for a given pressure.
- II Evaporation is a surface phenomenon while boiling is an interior phenomenon.
- III Evaporation is affected by surface areas which boiling is not.

- A. I and II only

- B. I and III only
- C. II and III only
- D. I, II and III.

26. A well-lagged bar of length 100cm has its ends maintained at 100°C and 40°C respectively. What is the temperature at a point 60cm from the hotter end?

- A. 58°C
- B. 62°C
- C. 64°C
- D. 76°C

27. Which of the following is the exclusive property of a transverse wave?

- A. Diffraction
- B. Refraction
- C. Compression
- D. Polarization

28. The wavelength of signal from a radio transmitter is 1500m and the frequency is 200kHz. What is the wavelength for a transmitter operating at 1000kHz?

- A. 7500 m
- B. 300 m
- C. 75 m
- D. 15 m

29. The difference between sound waves and light waves is that sound waves

- A. Are transverse while light waves are longitudinal.
- B. Require a medium to travel while light waves do not.
- C. Can be diffracted but light waves cannot
- D. Cannot be reflected but light waves can.

30. Which of the diagrams below represents the second overtone of a vibrating string fixed at both ends?

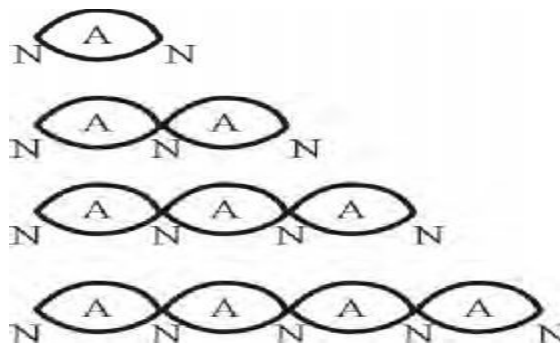

31. The pitch of an acoustic device can be increased by

- A. Increasing the frequency
- B. Increasing the amplitude
- C. Decreasing the loudness
- D. Decreasing the intensity

32. Total eclipse of the sun occurs when the

- A. Earth is between the moon and the sun
- B. Sun is between the moon and the earth
- C. Moon is between the sun and the earth
- D. Ozone layer is threatened

33. What is the approximate critical angle for total internal reflection for diamond if the refractive index of diamond is 2.42?

- A. 21° B. 22°
 C. 23° D. 24°

34. Which of the graphs represents the relationship between m and v for a converging mirror?

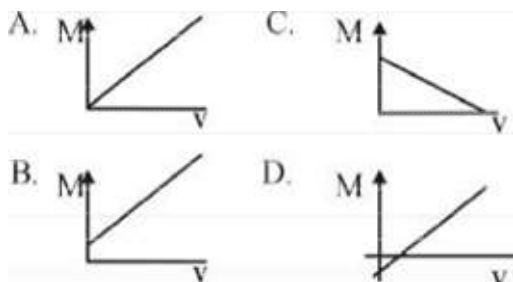

35. A real object is placed at a distance u cm in front of a curved mirror of focal length f cm. If the image is upright and magnified, then the mirror is

- A. Convex and $u = 2f$
 B. Concave and $u = 2f$
 C. Convex and $u = \frac{f}{2}$
 D. Concave and $u = \frac{f}{2}$

36. Which of the following pairs of colours gives the widest separation in the spectrum of white light?

- A. Red and violet
 B. Green and yellow
 C. Red and indigo
 D. Yellow and violet.

37. Two parallel plates at a distance of 8.0×10^{-3} m apart are maintained at p.d. of 600 volts with the negative plate earthed. What is the electric field strength?

- A. 4.8 Vm^{-1}
 B. 75.0 Vm^{-1}
 C. 4800.0 Vm^{-1}
 D. $7,5000.0 \text{ Vm}^{-1}$

38. At different locations on the earth's surface, the earth's magnetic field is

- A. The same in magnitude and direction
 B. The same in magnitude but different in direction
 C. Different in both magnitude and direction
 D. Different in magnitude but not in direction.

39. If a resistance is halved in value and the potential difference across it is tripled, then the ratio of the new current to the old is

- A. 1 : 6 B. 1 : 3
 C. 2 : 1 D. 6 : 1

40. A 12-V battery has an internal resistance of 0.5 ohms. If a cable of 1.0 ohms resistance is connected across the two terminals of the battery, the current drawn from the battery is

- A. 16.0 A B. 8.0 A
 C. 0.8 A D. 0.4 A

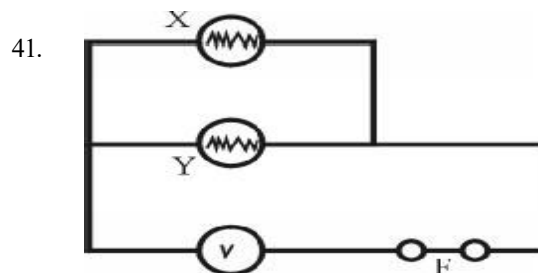

The diagram above shows two similar bulbs X and Y connected to a suitable power supply with F as an appropriate fuse rating. If the filament of X breaks, then the

- A. Brightness of Y will reduce
 B. Brightness of Y will remain constant
 C. Brightness of Y will remain constant
 D. Fuse F will blow.

42. The purpose of a dielectric material in a parallel plate capacitor is to

- A. Increase its capacitance
 B. Decrease its capacitance
 C. Insulate the plates from each other
 D. Increase the magnetic field between the plates.

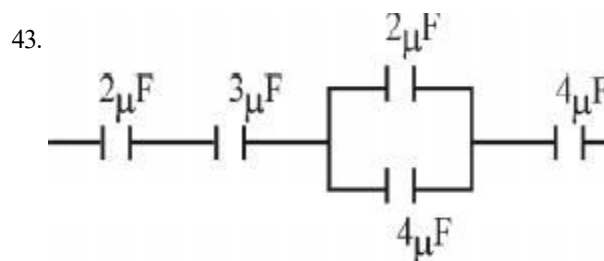

The resultant in the figure above is

- A. 15.0 uF B. 9.8 uF
 C. 1.3 uF
 D. 0.8 uF

44. An electric current of 2 amperes flows in a heating coil of resistance 50 ohms for 3 minutes 20 seconds. Determine the heat produced.

- A. 0.5 kJ B. 8.0 kJ
 C. 20.0 kJ D. 40.0 kJ

45. If the maximum voltage across a 100-ohm resistor is 20V, then the maximum power it can dissipate is

- A. 5.00 W B. 4.00 W

- C. 2.00 W D. 0.25 W
46. Which of the following is required to convert a milliammeter to an ammeter?
 A. A high resistance in parallel
 B. A high resistance in series
 C. A low resistance in parallel
 D. A low resistance in series.
47. The primary winding of a transformer has 400 turns and its secondary has 100 turns. If a source of e.m.f. of 12V is applied to the primary, the secondary e.m.f. will be
 A. 3 V B. 6 V
 C. 24V D. 48V
48. An alternating source is connected in series to a capacitor of capacity reactance of $10^3 \sqrt{3}$ and resistor of a resistance 10^3 Ohms. The impedance of the circuit is
 A. $2000\sqrt{3}$ Ohms
- B. 2000 Ohms
 C. $1000\sqrt{3}$ Ohms
 D. 1000 Ohms
49. The half-life of a radioactive element is 9 days. What fraction of atoms has decayed in 36 days?
 A. $\frac{1}{16}$
 B. $\frac{1}{4}$
 C. $\frac{1}{2}$
 D. $\frac{15}{16}$
50. A light of energy 5eV falls on a metal and the electrons with a maximum kinetic energy of 2eV are rejected. The work function of the metal is
 A. 0.4eV B. 2.5eV
 C. 3.0eV D. 7.0eV

Physics 1997

1. At what respective values of X, Y and Z would the unit of force, the Newton, be dimensionally equivalent to $M^X L^Y T^Z$?
 A. -1, 1, 2
 B. 1, 2, -2
 C. 1, -1, 2
 D. -1, 1, -2
2. The distance x m traveled by a particle in time t seconds is described by the equation $x = 10 + 12t^2$. Find the average speed of the particle between the time interval $t=2$ s and $t=5$ s.
 A. 60 ms^{-1} B. 72 ms^{-1}
 C. 84 ms^{-1} D. 108 ms^{-1}
3. A 5kg block is released from rest on a smooth plane inclined at an angle of 30° to the horizontal. What is its acceleration down the plane?
 A. 5.0 ms^{-2} B. 5.8 ms^{-2}
 C. 8.7 ms^{-2} D. 25.0 ms^{-2}
 [g = 10 ms^{-2}]
4. An arrow of mass 0.1kg moving with a horizontal velocity of 15 ms^{-1} is shot into a wooden block of mass 0.4 kg lying at rest on a smooth horizontal surface. Their common velocity after impact is
 A. 15.0 ms^{-1} B. 7.5 ms^{-1}
 C. 3.8 ms^{-1} D. 3.0 ms^{-1}
5. Two bodies X and Y are projected on the same horizontal plane, with the same initial speed but at angles 30° and 60° respectively to the horizontal. Neglecting air resistance, the ratio of the range of X to that of Y is
 A. 1:1 B. 1:2
 C. 3:1 D. 1:3
6. Which of the following with respect of a body performing simple harmonic motion are in phase?
 A. Displacement and velocity of the body.
 B. Displacement and force on the body
 C. Velocity and acceleration of the body.
 D. Force acting on the body and the acceleration.
7. A body of mass 2 kg moving vertically upwards has its velocity increased uniformly from 10 ms^{-1} to 40 ms^{-1} in 4s. Neglecting air resistance, calculate the upward vertical force acting on the body.
 A. 15N B. 20N
 C. 35N D. 45N
 [g = 10 ms^{-2}]
8. A planet has mass m_1 and is at a distance r_1 from the sun. A second planet has mass $m_2 = 10m_1$ and is at a distance of $r_2 = 2r_1$ from the sun. Determine

the ratio of the gravitational force experienced by the planets.

- A. 1:5 B. 2:5
C. 3:5 D. 4:5

9.

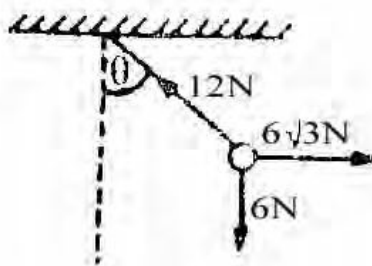

For what value of Q are the forces in the diagram above in equilibrium?

- A. 15° B. 30°
C. 45° D. 60°

10.

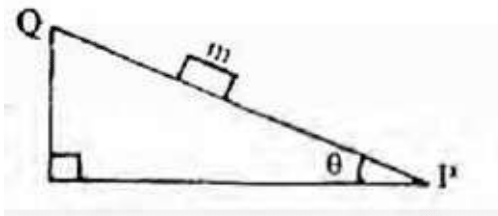

The figure above shows a block of mass m sliding down a rough inclined plane QP at angle Q . The forces acting on the block along the plane QP are

- A. $mg \sin Q$ and the normal reaction
B. $mg \sin Q$ and the force of friction
C. $mg \cos Q$ and the normal reaction
D. $mg \cos Q$ and the force of friction.

11.

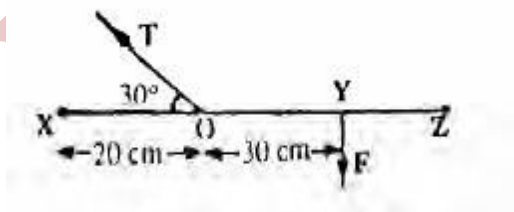

A uniform light beam XZ is hinged at X and kept in equilibrium by the forces T and F as shown in the diagram above. If $XO = 20 \text{ cm}$ and $OY = 30 \text{ cm}$, express T in terms of F .

- A. $T = \frac{2\sqrt{3}}{3} F$
B. $T = 2F$

- C. $T = \frac{5\sqrt{3}}{3} F$
D. $T = 5F$

12. An object of mass 100 g projected vertically upwards from the ground level has a velocity of 20 ms^{-1} at a height of 10 m . Calculate its initial kinetic energy at the ground level.

- A. 10 J B. 20 J
C. 30 J D. 50 J

[$g = 10 \text{ ms}^{-2}$; neglect air resistance]

13. An electric water pump rated 1.5 KW , lifts 200 kg of water through a vertical height of 6 metres in 10 seconds . What is the efficiency of the pump?

- A. 90.0% B. 85.0%
C. 80.0% D. 65.0%

[$g = 10 \text{ ms}^{-2}$; neglect air resistance]

14.

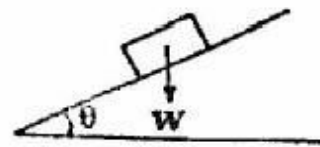

For a rough inclined plane on which lies a body of weight W , the angle θ in the diagram above becomes the angle of friction if

- A. $\tan Q =$ coefficient of static friction
B. $\cos Q =$ coefficient of dynamic friction
C. $\sin Q =$ coefficient of sliding friction
D. $\sec Q =$ limiting frictional force.

15. A load of 20 N on a wire of cross-sectional area $8 \times 10^{-7} \text{ m}^2$, produces an extension of 10^{-4} m . Calculate Young's modulus for the material of the wire if its length is 3 m .

- A. $7.0 \times 10^{11} \text{ Nm}^{-2}$
B. $7.5 \times 10^{11} \text{ Nm}^{-2}$
C. $8.5 \times 10^{11} \text{ Nm}^{-2}$
D. $9.0 \times 10^{11} \text{ Nm}^{-2}$

16. A cube of sides 0.1 m hangs freely from a string. What is the up thrust on the cube when totally immersed in water?

- A. 1000 N B. 700 N
C. 10 N D. 10 N

[Density of water is 1000 kg m^{-3} , $g = 10 \text{ ms}^{-2}$]

17. A piece of wire gauze can be made to lie on water because
- the wire gauze is less dense than water
 - the water molecules repel the wire gauze upwards.
 - the water surface has the effect of an elastic thin skin
 - of the cohesive forces between the water and the wire gauze molecules.
18. A liquid of mass 1.0×10^3 kg fills rectangular tank of length 2.5 m and width 2.0 m. If the tank is 4 m high, what is the pressure at the middle of the tank?
- $1.0 \times 10^4 \text{ Nm}^{-2}$
 - $2.0 \times 10^3 \text{ Nm}^{-2}$
 - $1.5 \times 10^3 \text{ Nm}^{-2}$
 - $1.0 \times 10^3 \text{ Nm}^{-2}$ ($g = 10 \text{ m/s}^2$)
19. An empty 60 litre petrol tank has a mass of 10 kg. Its mass when full of fuel of relative density 0.72 is
- 7.2k
 - 33.2kg
 - 43.2k
 - 53.2kg
20. The length of mercury thread when it is at 0°C , 100°C and at an unknown temperature θ is 25 mm, 225mm and 174mm respectively. The value of θ is
- 85.0°C
 - 80.0°C
 - 75.0°C
 - 70.0°C
21. Equal masses of copper and rubber are raised to the same temperature. After sometimes, the copper was observed to be at a lower temperature because
- the specific heat capacity of copper is lower than that of rubber
 - copper expands more than rubber
 - the specific heat capacity of rubber is lower than that of copper
 - rubber expands more than copper.
22. Before starting a journey, the tyre pressure of a car was $3 \times 10^5 \text{ Nm}^{-2}$ at 27°C . At the end of the journey, the pressure rose to $4 \times 10^5 \text{ Nm}^{-2}$. Calculate the temperature of the tyre after the journey assuming the volume is constant.
- 400°C
 - 300°C
 - 273°C
 - 127°C
23. A mass of a liquid at 300°C is mixed with a mass of the same liquid at 70°C and the temperature of the mixture is 45°C . Find the ratio of the mass of the cold liquid to the mass of the other liquid.
- 3 : 5
 - 5 : 3
 - 3 : 7
 - 7 : 3
24. A heating coil rated at 1000 W is used to boil off 0.5 kg of boiling water. The time taken to boil off the water is

- $1.15 \times 10^9 \text{ s}$
 - $1.15 \times 10^7 \text{ s}$
 - $1.15 \times 10^5 \text{ s}$
 - $1.15 \times 10^3 \text{ s}$
- [Specific latent heat of vaporization of water = $2.3 \times 10^6 \text{ J kg}^{-1}$]

25. What happens when a certain quantity of pure ice is completely changed to water at 0°C ?
- Latent heat is absorbed, the mass remains constant and the volume decreases.
 - Latent heat is given out, the mass remains constant and the volume decreases.
 - Latent heat is given out, the mass increases and the volume remains constant.
 - Latent heat is absorbed, the mass decreases and the volume increases.
26. The correct cooling curve for a molten substance such as naphthalene is represented by
- Temp. $^\circ\text{C}$

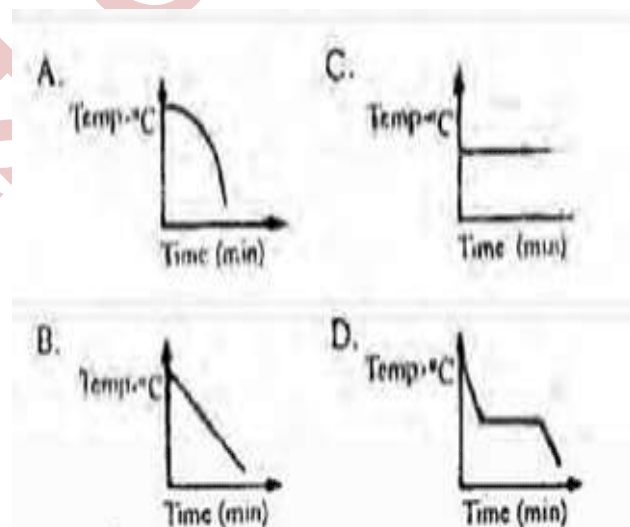

27. What happens when a gas expands at a constant temperature?
- Its pressure decreases.
 - The total momentum of its molecules remains constant.
 - Its pressure decreases and the total momentum of its molecules remains constant.
 - Its pressure decreases and the total kinetic energy of its molecules decreases.

28. Ripples on water and light waves are similar because both
- have the same frequency
 - can be refracted and diffracted
 - are longitudinal waves
 - have the same velocity.
29. Under constant tension and constant mass per unit length, the note produced by a plucked string is 500 Hz when the length of the string is 0.90 m. At what length is the frequency 150 Hz?
- 3m
 - 4m
 - 5m
 - 6m
30. The colours seen in thin films of oil on the road and in soap bubbles are due to
- Reflection
 - Interference
 - Diffraction
 - Polarization.

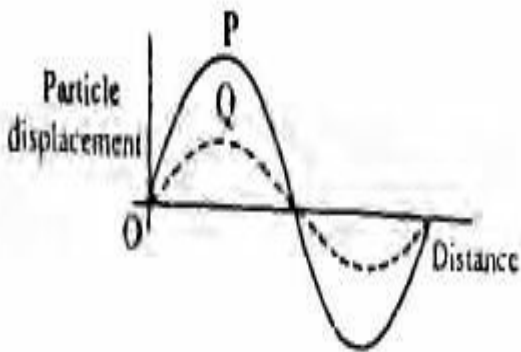

The diagram above shows two waveforms P and Q at a particular instant of time. The two waves will interfere

- destructively to produce a wave of a larger amplitude
 - destructively to produce a wave of a smaller amplitude
 - constructively to produce a wave of a larger amplitude
 - constructively to produce a wave of a smaller amplitude.
32. If the load at the end of a sonometer wire is immersed in a bucket of water, the original fundamental frequency of the wire could be restored by
- decreasing the length of the wire
 - increasing the length of the wire
 - increasing the mass per unit of the wire
 - changing the temperature of the water.

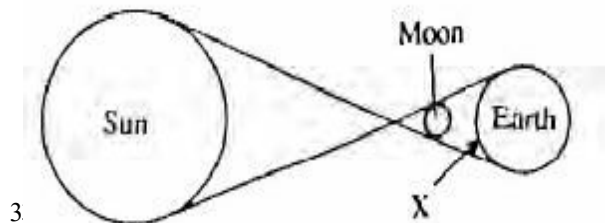

3

X

When the sun, the moon and the earth are as shown in the diagram above, an observer standing at X is in

- penumbra and sees a partial eclipse
 - penumbra and sees a total eclipse
 - umbra and sees a partial eclipse
 - umbra and sees a total eclipse.
34. A boy on looking into a mirror observed that his face appeared to have grown bigger. The boy must have been looking at a
- convex mirror with his face at the focus
 - concave mirror with his face between the focus and the mirror.
 - concave mirror with his face at the focus
 - convex mirror with his face between the focus and the mirror.
35. Light of velocity $3.0 \times 10^8 \text{ ms}^{-1}$ is incident on a material of refractive index n . If the velocity of light is reduced to $2.4 \times 10^8 \text{ ms}^{-1}$ in the material, what is n ?
- 2.33
 - 2.25
 - 1.33
 - 1.25
36. A patient with a sight defect has a distance of distinct vision of 150 cm. For him to be able to read a material placed at a distance of 25 cm, what is the focal length of the glasses he should wear?
- 15.0cm
 - 17.6cm
 - 21.4cm
 - 30.0cm
37. The electromagnetic waves that are sensitive to temperature changes are
- X-rays
 - gamma-rays
 - ultra-violet rays
 - infra-red rays.

38.

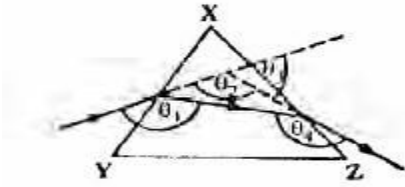

In the diagram above, which of the angles θ_1 , θ_2 , θ_3 , and θ_4 is the angle of deviation of a ray of light through the glass prism, XYZ?

- A. θ_1 B. θ_2
 C. θ_3 D. θ_4

39. Which of the figures below showed the correct distribution of charges on an isolated positively charged hollow metal?

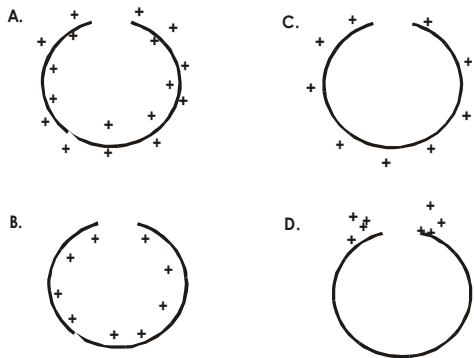

40. Three electric cells each of e.m.f. 1.5V and internal resistance 1.0 Ohms are connected in parallel across an external resistance of 7 Ohms. Calculate the value of the current in the resistor.

- A. 0.5A B. 0.9A
 C. 1.5A D. 4.5A

41. A galvanometer of internal resistance 50 Ohms has a full scale deflection for current of 5 mA. What is the resistance required to convert it to a voltmeter with full scale deflection of 10V?

- A. 1 750 Ohms B. 1 950 Ohms
 C. 2 000 Ohms D. 2 500 Ohms

42. If 8×10^{-2} J of work is required to move 100 μ C of charge from a point X to a point Y in an electrical circuit, the potential difference between X and Y is

- A. 4.0×10^2 V B. 4.0×10^4 V
 C. 8.0×10^2 V D. 8.0×10^4 V

43. In a metre bridge experiment, two resistors 2 Ω and 3 Ω occupy the left and right gaps

respectively. Find the balance point from the left side of the bridge.

- A. 20 cm B. 40 cm
 C. 60 cm D. 80 cm

44. Two 50 μ F parallel plate capacitors are connected in series. The combined capacitor is then connected across a 100-V battery. The charge on each plate of the capacitor is

- A. 5.00×10^{-5} C B. 2.50×10^{-3} C
 C. 1.25×10^{-3} C D. 1.00×10^{-2} C

45. What is the total electrical energy consumed by using an electric cooker rated 1000 W for 5 hrs?

- A. 5.3×10^3 J B. 6.5×10^3 J
 C. 1.8×10^7 J D. 2.3×10^7 J

46. The power dissipated in an a.c. circuit with an r.m.s. current of 5A, r.m.s. voltage of 10 V and a phase angle of 60° is

- A. 25 W B. 50 W
 C. 120 W D. 125 W

47. The voltage of the domestic electric supply is represented by the equation

$$V = 311 \sin 314.2t.$$

Determine the frequency of the a.c. supply.

- A. 50.0 Hz B. 100.0 Hz
 C. 311.0 Hz D. 314.2 Hz

$$[\pi = 3.142]$$

48. In a purely inductive circuit, the current

- A. lags behind the voltage in phase by 90°
 B. lead the voltage in phase by 90°
 C. is in the same phase with the voltage
 D. leads the voltage by 180° .

49. One of the features of the fission process is that

- A. Its products are not radioactive
 B. It leads to chain reaction
 C. Neutrons are not released
 D. The sum of the masses of the reactants equals the sum of the masses of the products.

50. The graphite rods surrounding the uranium fuel rods in a nuclear reactor, are used to

- A. Absorb the neutrons and hence halt the nuclear process
 B. Create the neutrons and hence start up the nuclear process.
 C. Slow down the neutrons and hence slow the nuclear process.
 D. Speed up the neutrons and hence speed up the nuclear process.

Physics 1998

1. The physical quantity that has the same dimensions as impulse is
 A. Energy B. Momentum
 C. Surface tension D. Pressure.
2. A ball is moving at 18ms^{-1} in a direction inclined at 60° to the horizontal. The horizontal component of its velocity is
 A. $9\sqrt{3}\text{ms}^{-1}$ B. $6\sqrt{3}\text{ms}^{-1}$
 C. $6\sqrt{3}\text{ms}^{-1}$ D. 9ms^{-1}

3.

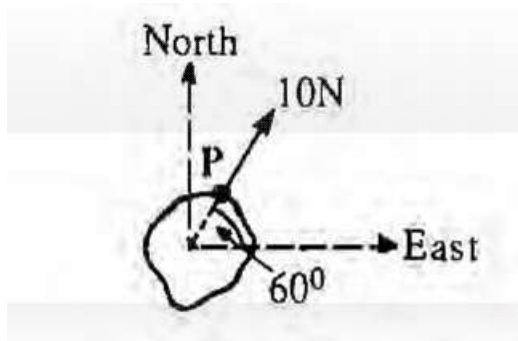

A body on the ground is acted on by a force of 10N at a point P as shown in the diagram above. What force is needed to stop the body from moving eastward?

- A. 5N in the direction of East
 B. 5N in the direction of West
 C. $5\sqrt{3}\text{N}$ in the direction of West.
 D. 10N in the Southwest direction.
4. In free fall, a body of mass 1kg drops from a height of 125m from rest in 5s. How long will it take another body of mass 2kg to fall from rest from the same height?
 A. 55 B. 105
 C. 125 D. 155
 ($g = 10\text{ms}^{-2}$)

5. A ball of mass 0.15kg is kicked against a rigid vertical wall with a horizontal velocity of 50ms^{-1} , calculate the impulse of the ball on the wall.
 A. 3.0Ns B. 4.5Ns
 C. 7.5Ns D. 12.0Ns
6. The force of attraction between two point masses is 10^{-4}N when the distance between them is 0.18m. If the distance is reduced to 0.06m, calculate the force.
 A. $1.1 \times 10^{-5}\text{N}$ B. $3.3 \times 10^{-5}\text{N}$
 C. $3.0 \times 10^{-4}\text{N}$ D. $9.0 \times 10^{-4}\text{N}$

7. In an experiment, a constant force is applied to several masses (m) and the corresponding accelerations (a) are measured. Which of the following graphs correctly represents the experiment?

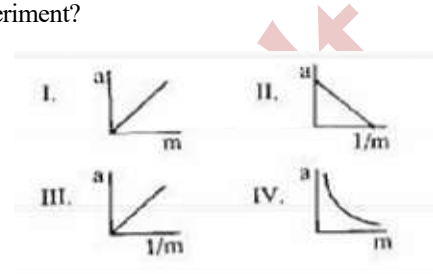

- A. III and IV only
 B. II and IV only
 C. I and III only
 D. I and II only

8. A uniform metre rule weighting 0.5N is to be pivoted on a knife-edge at the 30cm-mark. Where will a force of 2N be placed from the pivot to balance the metre rule?

- A. 95cm B. 25cm
 C. 20cm D. 5cm

9. A bullet fired at a wooden block of thickness 0.15m manages to penetrate the block. If the mass of the bullet is 0.025kg and the average resisting force of the wood is $7.5 \times 10^3\text{N}$, calculate the speed of the bullet just before it hits the wooden block.

- A. 450ms^{-1} B. 400ms^{-1}
 C. 300ms^{-1} D. 250ms^{-1}

10. A man whose mass is 80kg climbs a staircase in 20s and expends a power of 120W. Find the height of the staircase.

- A. 1.8m B. 2.0m
 C. 2.5m D. 3.0m

[$g = 10\text{ms}^{-2}$]

11. A parachute attains a terminal velocity when
 A. Its density is equal to the density of air
 B. The viscous force of the air and the upthrust completely counteract its weight.
 C. It expands as a result of reduced external pressure
 D. The viscous force of the is equal to the sum of the weight and upthrust.

12. In a wheel and axle mechanism, the diameters of the wheel and axle are 40cm and 8cm respectively. Given that the machine is 80% efficient, what effort is required to lift a load of 100N?
 A. 20N B. 25N
 C. 50N D. 80N
13. The tendon in a man's leg is 0.01m long. If a force of 5N stretches the tendon by 2.0×10^{-5} m, calculate the strain on the muscle.
 A. 5×10^6 B. 5×10^2
 C. 2×10^{-3} D. 2×10^{-7}
14. Which of these statements are correct for the pressures in liquids?
 I Pressure in a liquid at a point acts equally in all directions
 II Pressure increases with depth
 III Pressure at a depth depends on the shape of the container.
 IV Pressures at the same depth in different liquids are proportional to the densities of the liquids.
 A. I, II and III only
 B. I, II and IV only
 C. I, III and IV only
 D. II, III and IV only.
15. The atmospheric pressure due to water is 1.3×10^6 Nm⁻². What is the total pressure at the bottom of an ocean 10m deep?
 A. 1.3×10^7 Nm⁻² B. 1.4×10^6 Nm⁻²
 C. 1.4×10^5 Nm⁻² D. 1.0×10^5 Nm⁻²
16. A solid of weight 0.600N is totally immersed in oil and water respectively. If the upthrust in oil is 0.210N and the relative density of oil is 0.875 find the upthrust in water.
 A. 0.600N B. 0.360N
 C. 0.240N D. 0.180N
17. A platinum resistance thermometer records 3.0 Ω at 0 $^\circ$ C and 8.0 Ω at 100 $^\circ$ C. If it records 6.0 Ω in a certain environment, the temperature of the medium is
 A. 80 $^\circ$ C B. 60 $^\circ$ C
 C. 50 $^\circ$ C D. 30 $^\circ$ C
18. The linear expansivity of brass is 2×10^{-5} C⁻¹. If the volume of a piece of brass is 15.00 cm³ at 0 $^\circ$ C, what is the volume at 100 $^\circ$ C?
 A. 16.03cm³ B. 16.00cm³
 C. 15.09cm³ D. 15.03cm³
19. A gas has a volume of 100cm³ at 27 $^\circ$ C. If it is heated to temperature T until a final volume of 120cm³ is attained, calculate T.
 A. 33 $^\circ$ C B. 60 $^\circ$ C
 C. 87 $^\circ$ C D. 114 $^\circ$ C
20. A 500W heater is used to heat 0.6kg of water from 25 $^\circ$ C to 100 $^\circ$ C in t_1 seconds. If another 1000W heater is used to heat 0.2kg of water from 10 $^\circ$ C to 100 $^\circ$ C in t_2 seconds, find $\frac{t_1}{t_2}$
 A. 50 B. 5
 C. $\frac{5}{4}$ D. $\frac{1}{5}$
21. How many grams of water at 17 $^\circ$ C must be added to 42g of ice at 0 $^\circ$ C to melt the ice completely?
 A. 200g B. 300g
 C. 320g D. 400g
 [Specific latent heat of fusion of ice = 3.4×10^5 Jkg⁻¹, Specific heat capacity of water = 4200 Jkg⁻¹K⁻¹]
22. A vapour is said to be saturated when
 A. More molecules return to the liquid than the amount that left it.
 B. A dynamic equilibrium exist between the molecules of the liquid and the vapour molecules at a given temperature.
 C. The vapour pressure is equal to the atmospheric pressure
 D. All molecules are moving with the same speed in all directions at a given temperature.
23. One valid assumption of the kinetic theory of gases is that
 A. the molecules of a gas are constantly in state of motion and the number of collisions remain constant.
 B. The number of molecules of gas increases with increasing pressure
 C. As the temperature increases, the number of collisions made by the gas molecules remain constant.
 D. The molecules of gas are all identical and are very small in size.
24. The physical properties of sound waves can best be described by
 A. Reflection and diffraction
 B. Polarization and reflection
 C. Polarization and diffraction
 D. Polarization and refraction
25. The velocity of a sound wave at 27 $^\circ$ C is 360ms⁻¹. Its velocity at 127 $^\circ$ C is
 A. $120\sqrt{3}$ ms⁻¹ B. 240ms⁻¹
 C. $240\sqrt{3}$ ms⁻¹ D. $720\sqrt{3}$ ms⁻¹

26. In a closed organ pipe producing a musical note, an antinode will always be produced at
 A. The closed end
 B. The open end
 C. The middle
 D. All the parts of the pipe.
27. A steel wire of length 0.50m is stretched between two fixed points and its fundamental frequency is 200Hz. The speed of the wave in the wire is
 A. 100 ms^{-1} B. 120 ms^{-1}
 C. 200 ms^{-1} D. 250 ms^{-1}
28. In a resonance tube experiment, if the fundamental frequency of the vibrating air column is 280Hz, the frequency of the third overtones is
 A. 70Hz B. 840Hz
 C. 1120Hz D. 1960Hz
29. An object O lies at a distance m in front of a concave mirror of the focal length f . If $m < f$, then the final image obtained will be
 A. Virtual and diminished
 B. Magnified and erect
 C. Real and inverted
 D. Diminished and erect.
30. An object is placed in front of two plane mirrors inclined at an angle θ . If the total number of images formed is 7, find the value of θ ?
 A. 30° B. 45°
 C. 51° D. 90°
31. The most suitable type of mirror used for the construction of a searchlight is the
 A. Concave mirror
 B. Convex mirror
 C. Spherical mirror
 D. Parabolic mirror.
32. The displacement d produced in a glass block of thickness t and refractive index n when an object is viewed through it is
 A. $t - n$ B. $t(1 + \frac{1}{n})$
 C. $t(1 - \frac{1}{n})$ D. $t(\frac{1}{n} - 1)$
33. The correct shape of the graph of uv against $(u + v)$ for an object distance u and image distance v in an experiment to find the focal length of a convex lens is given as

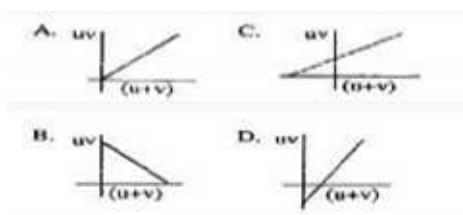

34. A man wears convex lens glasses of focal length 30cm in order to correct his eye defect. Instead of the optimum 25cm, his least distance of distinct vision is
 A. 14cm B. 28cm
 C. 75cm D. 150cm
35. Which of the following are true about infra-red radiation?
 I It is invisible
 II It is called heat ray
 III Its frequency is higher than that of blue light
 IV It travels as a transverse wave.
 A. I, II, III and IV.
 B. I, II and IV only
 C. I, III and IV only.
 D. II, III and IV only.
36. The force of repulsion between two point positive charges $5\mu\text{C}$ and $8\mu\text{C}$ separated at a distance of 0.02m apart is
 A. $1.8 \times 10^{-10}\text{N}$ B. $9.0 \times 10^{-8}\text{N}$
 C. $9.0 \times 10^2\text{N}$ D. $4.5 \times 10^3\text{N}$
37. An ebonite rod rubbed with fur attracts a glass rod rubbed with silk because
 A. Ebonite has a negative charge while glass has a positive charge
 B. Ebonite has a positive charge while glass has a negative charge
 C. Both have negative charges
 D. Both have positive charges.
38. Which of the following diagrams show the correction of the magnetic lines of force of a vertical wire XY carrying a current I?

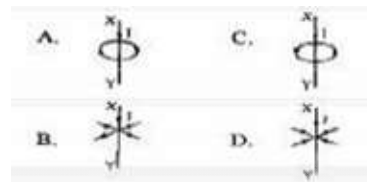

39. Which of the following can be used to reduce local action in a Leclanche cell?
 A. A carbon rod as the positive pole.
 B. Pure zinc as the negative pole.
 C. Potassium permanganate solution in contact with the positive pole.
 D. Common salt solution.

40.

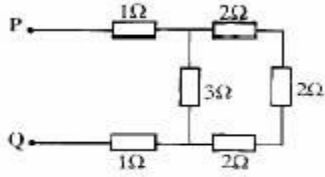

The total resistance measured at PQ in the diagram above is

- A. 18.0 Ohms B. 11.0 Ohms
C. 4.0 Ohms D. 2.0 Ohms

41. Find the work done in moving a 2C charges between two points X and Y in an electric field if the potential difference is 100 volts.

- A. 50J B. 100J
C. 200J D. 400J

42. A parallel capacitor has a common plate area of $5 \times 10^{-8} \text{m}^2$ and plate separation of $2 \times 10^{-3} \text{m}$. Assuming free space, what is the capacitance?

- A. $2.25 \times 10^{-17} \text{F}$
B. $4.50 \times 10^{-17} \text{F}$
C. $2.25 \times 10^{-16} \text{F}$
D. $4.50 \times 10^{-16} \text{F}$

43. The iron core of an induction coil is made from bundles of wires so as to

- A. Minimize eddy-currents
B. Generate eddy-currents
C. Prevent sparking at the contact breaker
D. Get the greatest possible secondary voltage.

44. Electricity is supplied to a school along a cable of total resistance 0.5Ω with the maximum current drawn from the mains as 100A. the maximum energy dissipated as heat for 1hr is

- A. $3.6 \times 10^3 \text{J}$ B. $5.0 \times 10^3 \text{J}$
C. $3.0 \times 10^5 \text{J}$ D. $1.8 \times 10^7 \text{J}$

45.

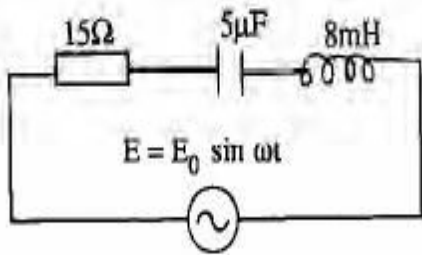

In the a.c. circuit diagram above, the resonance frequency is

- A. 5000δHz
B. 2500δHz
C. $\frac{5000}{\delta} \text{Hz}$
D. $\frac{2500}{\delta} \text{Hz}$

46. A transformer which can produce 8V from a 240V a.c. supply, has an efficiency of 80%. If the current in the secondary coil is 15A, calculate the current in the primary coil.

- A. 0.625A B. 1.600A
C. 2.500A D. 6.250A

47. The electrochemical equivalent of metal is $1.3 \times 10^{-7} \text{kgC}^{-1}$. The mass of the metal which $2.0 \times 10^4 \text{C}$ of electricity will deposit from a suitable electrolyte is

- A. $6.5 \times 10^{-2} \text{kg}$ B. $2.6 \times 10^{-2} \text{kg}$
C. $6.5 \times 10^{-3} \text{kg}$ D. $2.6 \times 10^{-3} \text{kg}$

48. A radioactive substance has a half-life of 80 days. If the initial number of atoms in the sample is 6.0×10^{10} , how many atoms would remain at the end of 320 days?

- A. 3.75×10^9 B. 7.50×10^9
C. 3.00×10^{10} D. 5.63×10^{10}

49. In a nuclear fusion experiment, the loss of mass amounts to $1.0 \times 10^{-6} \text{kg}$. The amount of energy obtained from the fusion is

- A. $3.0 \times 10^4 \text{J}$
B. $3.0 \times 10^{-1} \text{J}$
C. $9.0 \times 10^4 \text{J}$
D. $9.0 \times 10^{10} \text{J}$

[Speed of light = $3.0 \times 10^8 \text{ms}^{-1}$]

50. In photoelectric effect, electrons will leave the metal surface when illuminated by light of appropriate frequency if the photon energy is

- A. Greater than the work function.
B. Less than the work function
C. Equal to the work function
D. Equal to the maximum kinetic energy of the electrons.

Physics 1999

1. A car of mass 800kg attains a speed of 25ms^{-1} in 20 seconds. The power developed in the engine is
- A. $1.25 \times 10^4 \text{ W}$ B. $2.50 \times 10^4 \text{ W}$
 C. $1.25 \times 10^6 \text{ W}$ D. $2.50 \times 10^6 \text{ W}$

2. A lead bullet of mass 0.05kg is fired with a velocity of 200ms^{-1} into a lead block of mass 0.95 kg . Given that the lead block can move freely, the final kinetic energy after impact is
- A. 50 J B. 100 J
 C. 150 J D. 200 J

3. A ball of mass 0.1kg is thrown vertically upwards with a speed of 10 ms^{-1} from the top of a tower 10m high. Neglecting air resistance, its total energy just before hitting the ground is
- A. 5 J B. 10 J
 C. 15 J D. 20 J
 [$g = 10\text{ms}^{-2}$].

4.

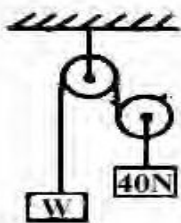

The figure above represents a frictionless pulley system in which a weight W is in equilibrium with a weight of 40N . Find the value of W

- A. 13.1N B. 20.0N
 C. 40.0N D. 80.0N

5.



The diagram above shows a solid figure with base PQ and centre gravity G on an inclined plane. Which of the following statements is correct?

- A. The solid will fall over if the vertical line through G lies outside the base.
 B. The solid will fall over if the vertical line through G lies inside the base.
 C. The solid will not fall over if the vertical line through G lies outside the base.
 D. The solid can never fall over.

6.

Two bodies have masses in the ratio $3 : 1$. They experience forces which impart to them accelerations in the ratio $2 : 9$ respectively. Find the ratio of the forces the masses experience.

- A. $1 : 4$
 B. $2 : 1$
 C. $2 : 3$
 D. $2 : 5$

7.

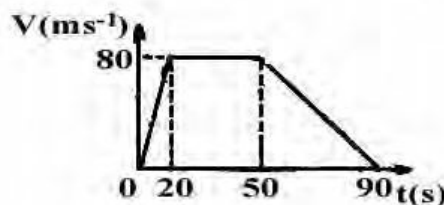

The diagram above shows the velocity-time graph of a vehicle. Its acceleration and retardation respectively are

- A. $8.0 \text{ ms}^{-2}, 4.0 \text{ ms}^{-2}$,
 B. $4.0 \text{ ms}^{-2}, 8.0 \text{ ms}^{-2}$,
 C. $4.0 \text{ ms}^{-2}, 2.0 \text{ ms}^{-2}$,
 D. $2.0 \text{ ms}^{-2}, 4.0 \text{ ms}^{-2}$

8.

A particle of mass 10^{-2}kg is fixed to the tip of a fan blade which rotates with angular velocity of 100 rad s^{-1} . If the radius of the blade is 0.2m , the centripetal force is

- A. 2 N B. 20 N
 C. 200 N D. 400 N

9.

The inner diameter of a small test tube can be measured accurately using a

- A. Micrometer screw gauge
 B. Pair of dividers
 C. Metre rule
 D. Pair of vernier calipers.

10.

A gas at a volume V_0 in a container at pressure P_0 is compressed to one fifth of its volume. What will be its pressure if it maintains its original temperature T ?

- A. $P_0/5$
 B. $4/5 P_0$
 C. P_0
 D. $5P_0$

11.

A piece of substance of specific heat capacity $450 \text{ J kg}^{-1} \text{ K}^{-1}$ falls through a vertical distance of 20m from rest. Calculate the rise in temperature of the

substance on hitting the ground when all its energies are converted into heat.

- A. $2/9^{\circ}\text{C}$ B. $4/9^{\circ}\text{C}$
 C. $9/4^{\circ}\text{C}$ D. $9/2^{\circ}\text{C}$
 [g = 10 ms^{-2}].

12.

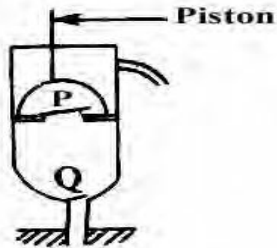

The diagram above shows a lift pump with valves at P and Q. during a downward stroke of the piston,

- A. Both valves are open
 B. P is open while Q is closed
 C. P is closed while Q is open
 D. Both valves are closed.

13.

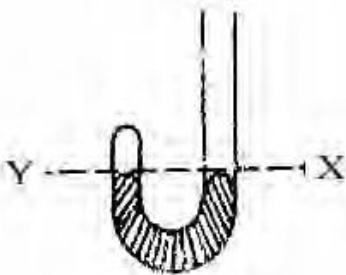

In the J – tube above, Y and X are on the same horizontal level and 30cm^3 of air is trapped above Y when the atmospheric pressure is 75cm Hg . Calculate the volume of air trapped above Y when 15cm Hg is now poured into the limb above X.

- A. 15 cm^3 B. 25 cm^3
 C. 35 cm^3 D. 45 cm^3

14.

If the stress on a wire is 10^7 Nm^{-2} and the wire is stretched from its original length of 10.00cm to 10.05 cm . The young's modulus of the wire is

- A. $5.0 \times 10^4\text{ Nm}^{-2}$ B. $5.0 \times 10^5\text{ Nm}^{-2}$
 C. $2.0 \times 10^8\text{ Nm}^{-2}$ D. $2.0 \times 10^9\text{ Nm}^{-2}$

15.

A solid weights 10.0N in air, 6.0 N when fully immersed in water and 7.0 N when fully immersed in a certain liquid X. Calculate the relative density of the liquid.

- A. $5/3$ B. $4/3$
 C. $3/4$ D. $7/10$

16.

- I. A liquid boils when its saturated vapour pressure is equal to the external pressure.
 II. Dissolved substances in pure water lead to increase in the boiling point.
 III. When the external pressure is increased, the boiling point increases.
 IV. Dissolved substances in pure water decrease the boiling point.

Which combination of the above are peculiarities of the boiling point of a liquid?

- A. I, II and III
 B. I, II, III and IV
 C. I, II and IV
 D. II, III and IV.

17.

When the temperature of a liquid is increased, its surface tension

- A. Decreases B. Increases
 C. Remains constant
 D. Increase then decreases.

18.

When the brakes in a car are applied, the frictional force on the tyres is

- A. A disadvantage because it is in the direction of motion of the car
 B. A disadvantage because it is in the opposite direction of motion of the car.
 C. An advantage because it is in the direction of motion of the car.
 D. An advantage because it is in the opposite direction of motion of the car.

19.

The lowest note emitted by a stretched string has a frequency of 400Hz . How many overtones are their between 40Hz and 180 Hz ?

- A. 4 B. 3
 C. 2 D. 1

20.

A man stands 4m in front of a plane mirror. If the mirror is moved 1m towards the man, the distance between him and his image is

- A. 3m B. 5m
 C. 6m D. 10m

21.

If a sound wave goes from a cold-air region to a hot-air region, its wavelength

- A. Increase
 B. Decrease
 C. Decrease then increase
 D. Remain constant

22.

The inside portion of part of a hollow metal sphere of diameter 20cm is polished. The portion will

therefore form a

- A. Concave mirror of focal length 5 cm
- B. Concave mirror of focal length 10 cm
- C. Convex mirror of focal length 5 cm
- D. Convex mirror of focal length 20 cm.

23. The equation of a wave traveling along the positive x-direction is given by $y = 0.25 \times 10^{-3} \sin(500t - 0.025x)$. Determine the angular frequency of the wave motion,

- A. $0.25 \times 10^{-3} \text{ rad s}^{-1}$
- B. $0.25 \times 10^{-1} \text{ rad s}^{-1}$
- C. $5.00 \times 10^2 \text{ rad s}^{-1}$
- D. $2.50 \times 10^2 \text{ rad s}^{-1}$

24. Calculate the mass of ice that would melt when 2kg of copper is quickly transferred from boiling water to a block of ice without heat loss

- A. 8/33kg
- B. 33/80kg
- C. 80/33kg
- D. 33/8kg

[Specific heat capacity of copper = $400 \text{ J kg}^{-1} \text{ K}^{-1}$;
Latent heat of fusion of ice = $3.3 \times 10^5 \text{ J kg}^{-1}$]

25.

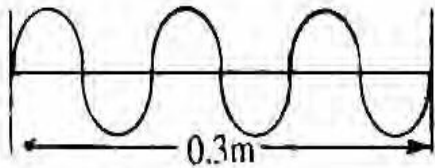

The diagram above represents a transverse electromagnetic wave traveling with speed $3.0 \times 10^8 \text{ ms}^{-1}$. What is the frequency of the wave?

- A. $3.0 \times 10^7 \text{ Hz}$
- B. $90 \times 10^7 \text{ Hz}$
- C. $1.0 \times 10^9 \text{ Hz}$
- D. $3.0 \times 10^9 \text{ Hz}$

27. The temperature gradient across a copper rod of thickness 0.02m, maintained a two temperature junctions of 20°C and 80°C respectively is

- A. $3.0 \times 10^2 \text{ Km}^{-1}$
- B. $3.0 \times 10^3 \text{ Km}^{-1}$
- C. $5.0 \times 10^3 \text{ Km}^{-1}$
- D. $3.0 \times 10^4 \text{ Km}^{-1}$

28.

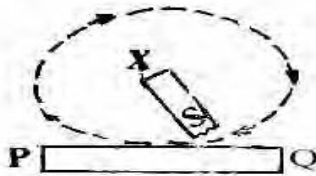

The diagram above show a magnet X with its South pole moved along a soft-iron bar PQ in the direction

shown. After some time, the poles at P and Q respectively are

- A. North – North
- B. North – South
- C. South – North
- D. South – South

29. Four cells each of e.m.f. 1.5 V and internal resistance of 4 Ohms are connected in parallel. What is the effective e.m.f. and internal resistance of the combination?

- A. 6.0V, 16 Ohms
- B. 6.0V, 1 Ohms
- C. 1.5V, 4 Ohms
- D. 1.5V, 1 Ohms

30.

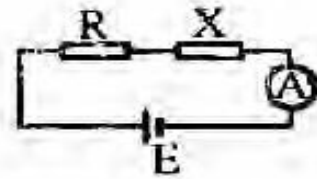

In the circuit above, the ammeter reads a current of 5.0 A when $R = 8 \text{ Ohms}$ and reads 7.0 A when $R = 5 \text{ Ohms}$. The value of the unknown resistance X is

- A. 10.0 Ohms
- B. 7.5 Ohms
- C. 5.0 Ohms
- D. 2.5 Ohms

31. An astronomical telescope is said to be in normal adjustment when the

- A. Eye is accommodated
- B. Focal length of objective lens is longer than that of eye piece
- C. Final image is at the near point of eye
- D. Final image is at infinity.

32. Steel is more suitable for permanent magnet than iron because the former

- A. Is easily demagnetized by shaking vigorously
- B. Is an alloy of many metals
- C. Is easily magnetized by alternating current through one cycle
- D. Retains magnetism more than iron.

33.

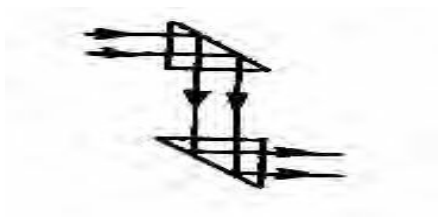

The diagram above shows the prism arrangement in a

- A. Binocular B. Spectrometer
C. Penscope D. Projector

34.

The velocities of flight air and glass are $3.0 \times 10^8 \text{ms}^{-1}$ and $2.0 \times 10^8 \text{ms}^{-1}$ respectively. If the angle of refraction is 30° , the sine of the angle of incidence is

- A. 0.33 B. 0.50
C. 0.67 D. 0.75

35.

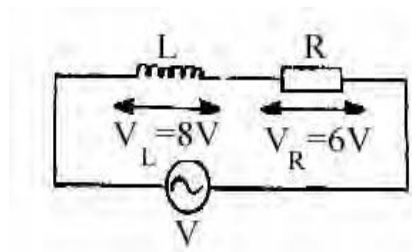

In the series a.c. circuit shown above, the p.d across the inductor is $8\sqrt{2}$ r.m.s. The effective voltage is

- A. 2V B. 10V
C. 14V D. 48V

36.

The core of an efficient transformer should consist of laminated pieces of metal in order to

- A. Increase the heat produced by increasing the eddy current
B. Increase the heat produced by reducing the eddy current
C. Reduce the heat produced by increasing the eddy current
D. Reduce the heat produced by reducing the eddy current.

37.

In Fleming's right-hand rule, the thumb, the forefinger and the middle finger if held mutually at right angles represent respectively, the

- A. Motion, the field and induced current
B. Induced current, the motion and the field
C. Field, the induced current and the motion
D. Induced current, the field and the motion.

38.

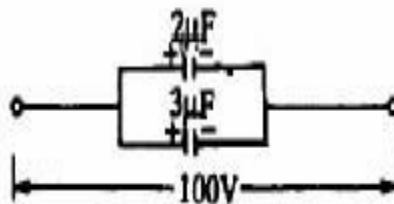

In the circuit above, the potential across each capacitor is 100V. The total energy stored in the two capacitors is

- A. $3.0 \times 10^4 \text{J}$ B. $3.0 \times 10^2 \text{J}$
C. $2.5 \times 10^{-2} \text{J}$ D. $6.0 \times 10^{-3} \text{J}$

39.

At what frequency would a 10 H inductor have a reactance of 2000 ohms?

- A. $\frac{8}{200} \text{Hz}$ B. $\frac{8}{100} \text{Hz}$
C. $\frac{100}{8} \text{Hz}$ D. $100\delta \text{Hz}$

40.

A 3000 W electric cooker is to be used on a 200V mains circuit. Which of the fuses below can be used safely with the cooker?

- A. 2A B. 5A
C. 10A D. 20A

42.

A galvanometer has a resistance of $5 \text{ }\Omega$. By using a shunt wire of resistance $0.05 \text{ }\Omega$, the galvanometer could be converted to an ammeter capable of reading 2 A. What is the current through the galvanometer?

- A. 2 mA B. 10 mA
C. 20 mA D. 25 mA

42.

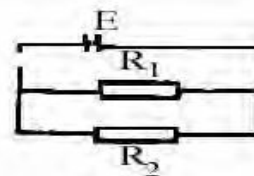

In the diagram above, if the internal resistance of the cell is zero, the ratio of the power P_1 and P_2 dissipated by R_1 and R_2 respectively, is

- A. $\frac{R_2}{R_1}$
B. $\frac{R_1}{R_2}$
C. $\frac{R_1 + R_2}{R_1}$
D. $\frac{R_1 + R_2}{R_2}$

43. If Δx is the uncertainty in the measurement of the position of a particle along the x-axis and " P_x is the uncertainty in the measurement of the linear momentum along the x-axis, then the uncertainty principle relation is given as
- $\Delta x \Delta P_x > h$
 - $\Delta x \Delta P_x = 0$
 - $\Delta x \Delta P_x < h$
 - $\Delta x \Delta P_x = 0$
44. $\text{Na} + \text{Proton} \rightarrow \text{X} + \text{alpha particle}$. What are the values of p and q respectively in the equation above?
- 10 and 20
 - 12 and 24
 - 20 and 10
 - 24 and 12.
45. A semi-conductor diode is used in rectifying alternating current into direct current mainly because it
- Allows current to flow in either direction
 - Is non-linear
 - Offers a high input resistance
 - Allows current to flow only in one direction.
46. In semi-conductors, the carriers of current at room temperature are
- Electrons only
 - Electrons and holes
 - Holes only
 - Electrons and ions
47. What is the speed of a particle of mass 10^{-27}kg whose wavelength is 10^{-8}m ?
- 6.63 ms^{-1}
 - 66.30 ms^{-1}
 - 663.00 ms^{-1}
 - 6630.00 ms^{-1}
48. In a series R-L-C circuit at resonance, the voltages across the resistor and the inductor are 30 V and 40 V respectively. What is the voltage across the capacitor?
- 30V
 - 40V
 - 50V
 - 70V
49. Gamma rays are produced when
- High velocity electrons are abruptly stopped in metals
 - Energy changes occur within the nucleus atoms
 - Energy changes occur within the electronic structure of atoms
 - Electrons are deflected in very strong magnetic fields.
50. In the Rutherford scattering experiment, a beam of alpha particles was fired at a thin gold film with some of the particles being considerably deflected. This shows that
- A gold nucleus contains protons, neutrons and electrons uniformly distributed in a tiny volume.
 - The gold nucleus is positively charged and is concentrated in a tiny volume
 - The gold nucleus emitted alpha particles
 - The gold nucleus is concentrated in a tiny volume and contains alpha particles.

Physics 2000

- A catapult used to hold a stone of mass 500g is extended by 20cm with an applied force f . If the stone leaves with a velocity of 40 ms^{-1} , the value of F is
 - $4.0 \times 10^4 \text{ N}$
 - $4.0 \times 10^3 \text{ N}$
 - $2.0 \times 10^3 \text{ N}$
 - $4.0 \times 10^2 \text{ N}$
- A hand bag containing some load weighting 162N is carried by two students each holding the handle of the bag next to him. If each handle is pulled at 60 to the vertical, find the force on each student's arm
 - 324N
 - 162N
 - 121N
 - 81N
- The frictional force is independent of the area of the surfaces in contact,
 - The frictional force depends on the nature of the surfaces in contact
 - The frictional force depends on the speed sliding
 - The frictional force is directly proportional to the normal reaction

Which combination of the above is true of sliding friction?

 - I, II and IV
 - I, II and III
 - I, III and IV
 - II, III and IV.

4. When a ship sails from salt water into fresh water, the friction of its volume above the water surface will
- Remain the same
 - Increase
 - Decrease
 - Increase then decrease.

5. A simple pendulum has a period of 17.0s. When the length is shortened by 1.5m, its period is 8.5s. Calculate the original length of the pendulum.
- 1.5m
 - 2.0m
 - 3.0m
 - 3.0m

6. At a fixed point below a liquid surface, the pressure downward is P_1 and the pressure upward is P_2 . It can be deduced that
- $P_1 = P_2$
 - $P_1 > P_2$
 - $P_1 < P_2$
 - $P_1 > P_2$

7. I. Its velocity is constant
 II. No work is done on the body
 III. It has constant acceleration away from the center
 IV. The centripetal force is directed towards the center.

Which combination of the above is true of a body moving with constant speed in a circular track?

- I and III
- I and IV
- II and III
- II and IV

8. The velocity v of a particle in a time t is given by the equation $v = 10 + 2t^2$. Find the instantaneous acceleration after 5 seconds.
- 10 ms^{-2}
 - 15 ms^{-2}
 - 20 ms^{-2}
 - 60 ms^{-2}

9. If the force and the velocity on a system are each reduced simultaneously by half, the power of the system is
- Doubled
 - Constant
 - Reduced to a quarter
 - Reduced by half.

10. The velocity ratio of a machine is 5 its efficiency is 75%. What effort would be needed to lift a load of 150N with the machine?
- 50N
 - 40N
 - 30N
 - 20N

11. A rope is being used to pull a mass of 10kg vertically upward. Determine the tension in the rope if, starting from rest, the mass acquires a velocity of 4 ms^{-1} in 8.
- 105N
 - 95N
 - 50N
 - 5N

12. A stream is flowing at 0.75 ms^{-1} and a boat heading perpendicular for the stream landed at the opposite bank at an angle 30° . Calculate the velocity of the boat.

- 0.65 ms^{-1}
- 0.86 ms^{-1}
- 1.00 ms^{-1}
- 1.50 ms^{-1}

13. I. Coherence
 II. Same frequency
 III. Same wavelength
 IV. Same intensity.

Which of the conditions above are necessary to produce interference fringes?

- I, II and III
- I, II and III
- I, II and IV
- II and III.

14. An engineer intends to deviate a light ray from its path 120° through reflection from plane mirror. Calculate the angle of incidence.

- 20°
- 30°
- 40°
- 60°

15.

	Days 1	Day 2	Day 3
Dry	30°C	29°C	25°C
Wet	22°C	22°C	21°C

The readings above are for three consecutive days from a wet and dry bulb hygrometer. It can be concluded that the relative humidity for the three days

- Increased steadily
- Remained unchanged
- Was least on day 1
- Decrease steadily

16. Total internal reflection occurs when light moves from

- Air to water
- Water to glass
- A dense medium to a less dense medium
- A less dense medium to a dense medium

17. One end of a long wire is fixed while vibrator is attached to the other end. When the vibrator is energized, the types of waves generated in the wire are

- Stationary and transverse
- Progressive
- Stationary and longitudinal
- Progressive and longitudinal.

18. A sonometer wire is vibrating at frequency f_0 . If the tension in the wire is doubled while the length and the mass per unit length are kept constant, the new frequency of vibration is
- A. $\frac{f_0}{2}$
 B. $2f_0$
 C. $\frac{f_0}{\sqrt{2}}$
 D. $f_0 \sqrt{2}$
19. A boy observes a piece of stone at the bottom of a river 6.0m deep. If he looks from the surface of the river, what is the apparent distance of the stone from him.
- A. 4.5m B. 5.0m
 C. 5.5m D. 8.0m
20. A metal of mass 0.5kg is heated to 100°C and then transferred to a well-lagged calorimeter of heat capacity 80J K^{-1} containing water of heat capacity 420J K^{-1} at 15°C . If the final steady temperature of the mixture is 25°C , find the specific heat capacity of the metal
- A. $92\text{J kg}^{-1}\text{K}^{-1}$ B. $133\text{J kg}^{-1}\text{K}^{-1}$
 C. $286\text{J kg}^{-1}\text{K}^{-1}$ D. $887\text{J kg}^{-1}\text{K}^{-1}$

21.

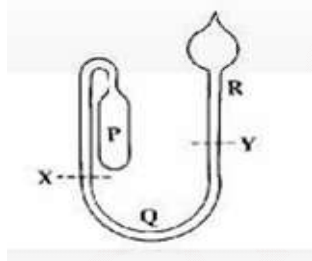

The diagram above shows a maximum and minimum thermometer divided into three portions P, Q and R. Which of the following is true about the respective contents of P, Q and R?

- A. Alcohol, mercury and alcohol
 B. Air, alcohol and mercury
 C. Mercury, alcohol and mercury
 D. Air, mercury and alcohol.
22. The main reason for making the cover of a vacuum flask airtight is to prevent heat loss by
- A. Conduction B. Evaporation
 C. Radiation D. Convection
23. A travelling wave moving from left to right has an amplitude of 0.15m, a frequency of 550Hz and a wavelength of 0.01m. The equation describing the wave is
- A. $y = 0.15 \sin 200 \pi (x - 5.5)$
 B. $y = 0.15 \sin \pi (0.01x - 5.5)$
 C. $y = 0.15 \sin 5.5 \pi (x - 200)$
 D. $y = 0.15 \sin \pi (550x - 0.01)$

24. A transverse wave is applied to a string whose mass per unit is $3 \times 10^{-2}\text{kgm}^{-1}$. If the string is under a tension of 12N, the speed of propagation of the wave is
- A. 40ms^{-1} B. 30ms^{-1}
 C. 20ms^{-1} D. 5ms^{-1}
25. A quantity of water at 0°C heated to about 30°C . At each degree rise in temperature, its density will
- A. Rise steadily B. Rise then fall
 C. Fall steadily D. Fall then rise.
26. A thin wire with heavy weights attached to both ends is hung over a block of ice resting on two supports. If the wire cuts through the ice block while the block remains solid behind the wire, the process is called
- A. Fusion B. Sublimation
 C. Condensation D. Regelation
27. A cell of internal resistance 0.01 ohms can be measured accurately using the
- A. Ohm-meter
 B. Potentiometer
 C. Electroscope
 D. Metre bridge

28.

- An electron of charge $1.6 \times 10^{-19}\text{C}$ and mass $9.1 \times 10^{-31}\text{kg}$ is accelerated between two metal plates with a velocity of $4 \times 10^7\text{ms}^{-1}$, the potential difference between the plates is
- A. $4.55 \times 10^1\text{V}$ B. $9.10 \times 10^1\text{V}$
 C. $4.55 \times 10^2\text{V}$ D. $4.55 \times 10^3\text{V}$

29.

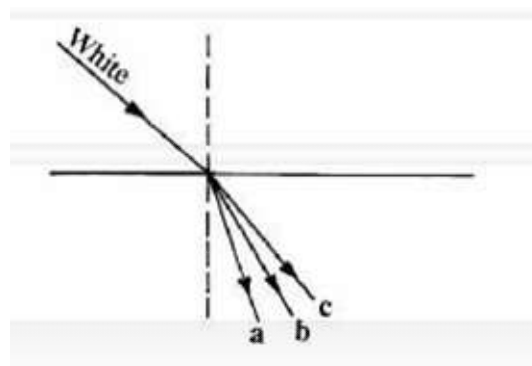

In the diagram above, a beam of white light travels from a rare to dense medium. What colours of light do the rays a, b, c respectively represent.

- A. Blue, yellow and red
 B. Green, red and blue
 C. Red, green and blue
 D. Yellow, blue and red.

30.

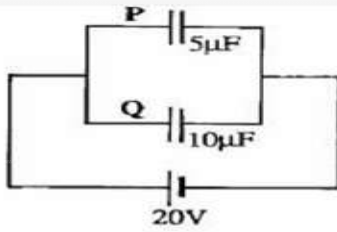

The diagram above shows two capacitors P and Q of capacitances $5\mu\text{F}$ and $10\mu\text{F}$. Find the charges stores in P and Q respectively.

- A. $200\mu\text{C}$ and $100\mu\text{C}$
- B. $100\mu\text{C}$ and $200\mu\text{C}$
- C. $4\mu\text{C}$ and $2\mu\text{C}$
- D. $2\mu\text{C}$ and $4\mu\text{C}$

31. What optical instrument can best be constructed with converging lenses of focal lengths 500cm and 5cm ?

- A. Compound microscope
- B. Terrestrial telescope
- C. Astronomical telescope
- D. Galileo's telescope

32. If a charged ion goes through combined electric and magnetic fields, the resultant emergent velocity of the ion is

- A. $\frac{E}{B}$
- B. EB
- C. $\frac{B}{E}$
- D. $E - B$

33.

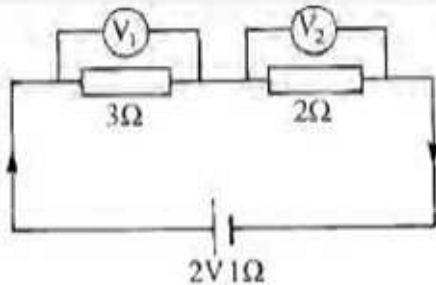

In the diagram above, the values of V^1 and V^2 are respectively

- A. 1V and $\frac{1}{3}\text{V}$
- B. $\frac{1}{3}\text{V}$ and 1V
- C. $\frac{1}{3}\text{V}$ and $\frac{2}{3}\text{V}$
- D. 1V and $\frac{2}{3}\text{V}$

34.

A projector lantern is used to give the image of a slide on a screen. If the image is 24 times as large as the slide and the screen is 72.0m from the projecting lens, what is the position of the slide from the lens?

- A. 4.0m
- B. 3.5m
- C. 3.0m
- D. 0.3m

35.

A radio is operated by eight cells each of e.m.f. 2.0V connected in series. if two of the cells are wrongly connected, the net e.m.f. of the radio is

- A. 16V
- B. 12V
- C. 10V
- D. 8V

36.

A 2H inductor has negligible resistance and is connected to a $50\pi\text{Hz}$ a.c. supply. The reactance of the inductor is

- A. 200 Ohms
- B. 50 Ohms
- C. $\frac{100}{\pi}\text{ Ohms}$
- D. $\frac{25}{\pi}\text{ Ohms}$

37.

If the fraction of the atoms of a radioactive material left after 120 years is $\frac{1}{64}$. What is the half-life of the material?

- A. 2 years
- B. 10 years
- C. 20 years
- D. 24 years

38.

A certain radioactive source emits radiations that were found to be deflected by both magnetic and electric fields. The radiations are

- A. x-rays
- B. beta rays
- C. gamma rays
- D. ultra-violet rays

39.

In a pure semiconductor, the number of electron in the conduction band is

- A. Equal to the number of holes in the valence band
- B. Greater than the number of holes in the valence band
- C. Less than the number of holes in the valence band
- D. Twice the number of holes in the valence band.

40.

A cell of internal resistance 1 ohms supplies current to an external resistor of 3 ohms . The efficiency of the cell is

- A. 75%
- B. 50%
- C. 33%
- D. 25%

41. Light energy 5eV falls on a metal of work function 3eV and electrons are liberated. The stopping potential is
- A. 15.0V B. 8.0V
 C. 2.0V D. 1.7V

42. In the thermonuclear reaction, the total initial mass is $5.02 \times 10^{-27}\text{kg}$. The energy released in the process is
- A. $9.0 \times 10^{-10}\text{J}$ B. $9.0 \times 10^{-11}\text{J}$
 C. $9.0 \times 10^{-12}\text{J}$ D. $9.0 \times 10^{-13}\text{J}$

43. The magnetic flux in a coil having 200 turns changes at the time rate of 0.08 Wb s^{-1} . The induced e.m.f. in the coil is
- A. 1.6V B. 16.0V
 C. 25.0V D. 250.0V

44. If the frequency of an emitted x-rays is $1.6 \times 10^{16}\text{ Hz}$, the accelerating potential is
- A. 6.6 V B. 66.3 V
 C. 663.0 V D. 6630.0 V

45.

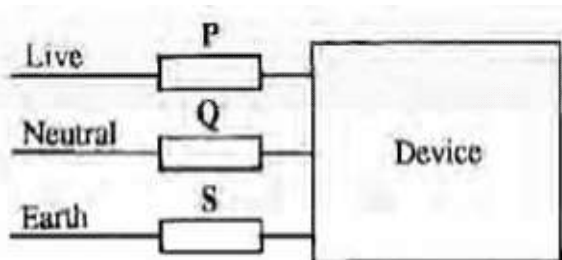

The correct position for a fuse in the diagram above is

- A. S B. Q
 C. P D. Between P and Q

46.

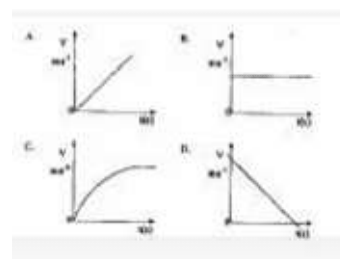

In the a.c. circuit above, the current value is

- A. 6.67A
 B. 4.00A
 C. 3.00A
 D. 0.58A

47.

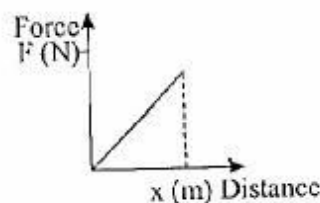

If current flows in the direction of the arrows in the solenoid above, the North pole is at

- A. P B. X
 C. Q D. Y

48.

- A gas would serve as an electrical conductor under
- A. Reduced pressure and reduced potential
 B. Reduced pressure and high current
 C. Increased magnetic field
 D. Exposure to visible light

49.

- An electric generator with a power output of 3.0kW at a voltage of 1.5kV distributes power along cables of total resistance 20.0 ohms . the power loss in the cable is
- A. 0.1W B. 10.0W
 C. 40.0W D. 80.0W

50.

- A conductor of length 2m carries a current of 0.8A while kept in a magnetic field of magnetic flux density 0.5T . The maximum force acting on it is
- A. 8.0N B. 3.2N
 C. 0.8N D. 0.2N

Physics 2001

1.

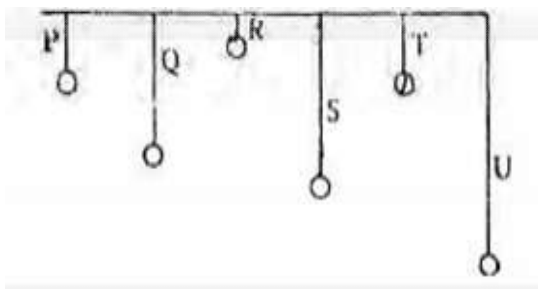

In the diagram above, which of the simple pendulum will resonate with P when set into oscillation?

- A. T B. U
C. R and T D. Q and R

2.

The height at which the atmosphere ceases to exist is about 80km. If the atmospheric pressure on the ground level is 760 mmHg, the pressure at a height of 20km above the ground level is

- A. 380mmHg B. 570mmHg
C. 190mmHg D. 480mmHg

3.

A stone of mass 1 kg is dropped from a height of 10m above the ground and falls freely under gravity. Its kinetic energy 5m above the ground is then equal to

- A. Its kinetic energy on the ground
B. Twice its initial potential energy
C. Its initial potential energy
D. Half its initial potential energy

4.



The diagram above is a block-and-tackle pulley system in which an effort of 80N is used to lift a load of 240N. the efficiency of the machine is

- A. 60% B. 50%
C. 40% D. 33%

5.

If a spherical metal bob of radius 3cm is fully immersed in a cylinder containing water and the water level rises by 1cm, what is the radius of the cylinder?

- A. 12cm B. 1cm
C. 3cm D. 6cm

6.

The resultant of two forces acting on an object is maximum if the angle between them is

- A. 45° B. 0°
C. 90° D. 180°

7.

- I. The earth is not spherical but elliptical in shape
II. Variation in latitude and longitude
III. Rotation of the earth on its axis
IV. Variation in the density of the earth

On which combination of the above does the weight of an object vary on the earth's surface?

- A. I, II, III and IV
B. II, III and IV only
C. I, II and III only
D. I and II only.

8.

The efficiency of a machine is always less than 100% because the

- A. Work output is always greater than the work input
B. Load lifted is always greater than the effort applied
C. Effort applied is always greater than the load lifted
D. Velocity ratio is always greater than the mechanical advantage.

9.

Which of the following consists entirely of vector quantities?

- A. Velocity, magnetic flux and reaction.
B. Tension, magnetic flux and mass
C. Displacement, impulse and power
D. Work, pressure and moment.

10.

Ice cubes are added to a glass of warm water. The glass and water are cooled by

- A. Conduction only
B. Convection only
C. Conduction and convection
D. Convection and radiation

11. A ray of light strikes a plane mirror at an angle of incidence of 35° . If the mirror is rotated through 10° , through what angle is the reflected ray rotated?
 A. 70° B. 45°
 C. 25° D. 20°
12. Find the frequencies of the first three harmonic of a piano string of length 1.5m, if the velocity of the waves on the string is 120ms^{-1} .
 A. 80 Hz, 80 Hz, 120 Hz
 B. 80 Hz, 160 Hz, 240 Hz
 C. 180 Hz, 360 Hz, 540 Hz
 D. 360 Hz, 180 Hz, 90 Hz
 E.
13. The terrestrial telescope has one extra lens more than the astronomical telescope. The extra lens is for
 A. Improving the sharpness
 B. Creating an inverted image
 C. Magnification of the image
 D. Erection of the image
14. The driving mirror of a car has a radius of curvature of 1m. A vehicle behind the car is 4m from the mirror. Find the image distance behind the mirror.
 A. $\frac{8}{7}$ B. $\frac{4}{9}$ C. $\frac{9}{2}$ D. $\frac{4}{7}$
- 15.

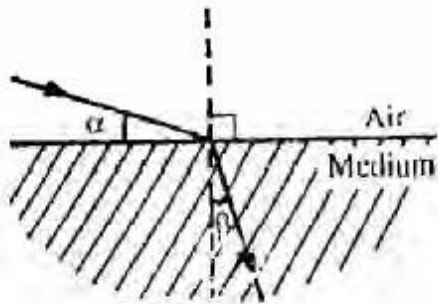

If a ray traveling in air is incident on a transparent medium as shown in the diagram, the refractive index of the medium is given as

- A. $\frac{\cos \alpha}{\sin \beta}$ B. $\frac{\sin \alpha}{\sin \beta}$
 C. $\frac{\cos \beta}{\sin \alpha}$ D. $\frac{\sin \beta}{\sin \alpha}$

The pressure of a mass of a gas changes from 300Nm^{-2} to 120Nm^{-2} while the temperature drops from 1270C to -73oc . The ratio of the final volume to the initial volume is

- A. 2 : 5 B. 5 ; 4
 C. 5 ; 2 D. 4 ; 5
17. A plane sound wave of frequency 85.5 Hz and velocity 342 ms^{-1} is reflected from a vertical wall.

At what distance from the wall does the wave have an antinode?

- A. 2m B. 4m
 C. 1m D. 3m
18. A string is fastened tightly between two walls 24cm apart. The wavelength of the second overtone is
 A. 24cm B. 16cm
 C. 12cm D. 8cm
19. A gas with initial volume of $2 \times 10^{-6}\text{m}^3$ is allowed to expand to six times its initial volume at constant pressure of $2 \times 10^5\text{Nm}^{-2}$. The work done is
 A. 2.0J B. 4.0J
 C. 12.0J D. 1.2J
20. The thermometric substance of an absolute thermometer is
 A. Alcohol B. Mercury
 C. Helium D. Platinum
21. A cell of internal resistance r supplies current to a 6.0 Ohms resistor and its efficiency is 75%. Find the value of r
 A. 4.5 Ohms
 B. 1.0 Ohms
 C. 8.0 Ohms
 D. 2.0 Ohms
- 22.

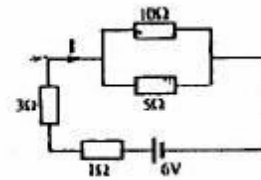

In the diagram above, the current I is

- A. $3/8\text{A}$ B. $9/11\text{A}$
 C. $11/9\text{A}$ D. $8/3\text{A}$

23.

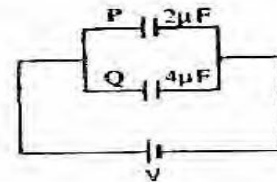

The diagram above shows two capacitors P and Q of capacitances $2\mu\text{F}$ and $4\mu\text{F}$ respectively

connected to a.d.c. source. The ratio of energy stored in P to Q is

- A. 4 : 1 B. 2 : 1
C. 1 : 4 D. 1 : 2

24. A resistance R is connected across the terminal of an electric cell of internal resistance 2 Ohms and the voltage was reduced to 3/5 of its nominal value. The value of R is

- A. 3 Ohms B. 2 Ohms
C. 1 Ohms D. 6 Ohms

25.

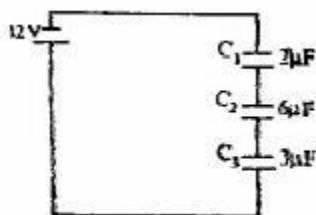

The diagram above shows three capacitors C_1 , C_2 and C_3 of capacitances 2µF, 6 µF and 3 µF respectively. The potential differences across C_1 , C_2 and C_3 respectively are

- A. 4V, 6V and 2V
B. 2V, 6V and 4V
C. 6V, 4V and 2V
D. 6V, 2V and 4V

26. A student is at a height 4m above the ground during a thunderstorm. Given that the potential difference between the thundercloud and the ground is 10^7 V, the electric field created by the storm is

- A. $2.0 \times 10^6 \text{NC}^{-1}$ B. $2.5 \times 10^6 \text{NC}^{-1}$
C. $1.0 \times 10^7 \text{NC}^{-1}$ D. $4.0 \times 10^7 \text{NC}^{-1}$

27. A working electric motor takes a current of 1.5A when the p.d. across it is 250V. If its efficiency is 80%, the power output is

- A. 300.0W B. 469.0W
C. 133.0W D. 4.8W

28. The cost of running five 60 W lamps and four 100W lamps for 20 hours if electrical energy costs N10.00 per kWh is

- A. N280.00 B. N160.00
C. N120.00 D. N140.00

29. In a Daniel cell, the depolarize, positive and negative electrodes are respectively

- A. Copper sulphate, copper and zinc
B. Manganese dioxide, carbon and zinc

- C. Sulphuric acid, lead oxide and lead
D. Potassium hydroxide, nickel and iron

30.

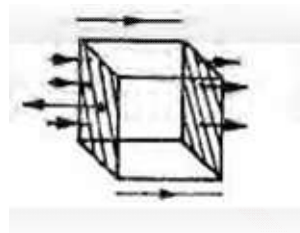

The diagram above shows a closed square box of side 0.5m in a uniform electric field E in the direction shown by the arrows. What is the flux for the box?

- A. 0.5E B. 2.0E
C. 0.2E D. 0.0E

31.

A bread toaster uses a current of 4A when plugged in a 240 volts line. It takes one minute to toast slices of bread. What is the energy consumed by the toaster?

- A. $5.76 \times 10^4 \text{J}$ B. $1.60 \times 10^4 \text{J}$
C. $3.60 \times 10^3 \text{J}$ D. $1.60 \times 10^2 \text{J}$

32.

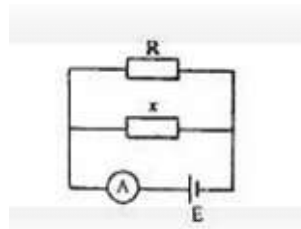

In the circuit diagram above, the ammeter reads a current of 3A when R is 5 Ohms and 6A when R is 2 Ohms. Determine the value of x

- A. 8 Ohms B. 2 Ohms
C. 10 Ohms D. 4 Ohms

33.

When a piece of rectangular glass block is inserted between two parallel plate capacitor, at constant plate area and distance of separation, the capacitance of the capacitor will

- A. Increase
B. Decrease
C. Decrease, then increase
D. Remain constant

34.

The ratio of electrostatic force F_E to gravitational force F_G between two protons each of charge e and mass m, at a distance d is

- A. $\frac{e}{4\pi\epsilon_0 Gm}$ B. $\frac{e^2}{Gm^2}$ C. $\frac{Gm^2}{4\pi\epsilon_0 e^2}$
D. $\frac{e^2}{4\pi\epsilon_0 Gm^2}$

35. What is the angle of dip at the magnetic equator?
 A. 450 B. 0°
 C. 90° D. 180°
36. A cell can supply currents of 0.4A and 0.2A through a 4.0 Ohms and 10.0 Ohms resistors respectively. The internal resistance of the cell is
 A. 2.0 Ohms B. 1.0 Ohms
 C. 2.5 Ohms D. 1.5 Ohms
37. Which of the following graphs correctly represents the variation of mass of a given material deposited with time for constant current in Faraday's law of electrolysis?

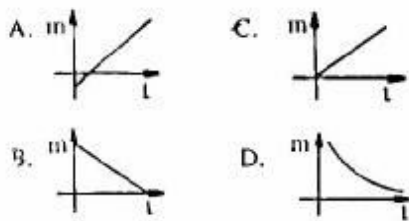

38.

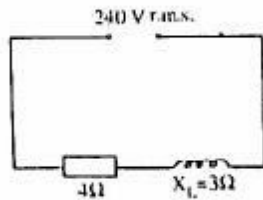

In the diagram above, determine the r.m.s. current

- A. 31A B. 48A
 C. 60A D. 80A
39. The particle emitted when ${}^3_9\text{K}$ decays to ${}^3_9\text{K}$ is
 A. Gamma B. Beta
 C. Electron D. Alpha
40. The current through a resistor in a.c. circuit is given as $2 \sin \omega t$. Determine the d.c. equivalent of the current
 A. $\frac{1}{\sqrt{2}}$ A
 B. $2\sqrt{2}$ A
 C. 2 A
 E. $\sqrt{2}$ A
41. I Low pressure
 II High pressure
 III High potential difference
 IV Low potential difference

- Which combination of the above is true of the conduction of electricity through gases?
 A. I and IV only
 B. I and III only
 C. II and IV only
 D. II and III only

42. Which of the following metals will provide the greatest shield against ionizing radiation?
 A. Iron B. Manganese
 C. Aluminium D. Lead
43. The primary coil of a transformer has N turns and is connected to a 120 V a.c. power line. If the secondary coil has 1,000 turns and a terminal voltage of 1,200 volts, what is the value of N ?
 A. 120 B. 100
 C. 1,000 D. 1,200
44. The process of energy production in the sun is
 A. Nuclear fission
 B. Nuclear fusion
 C. Electron collision
 D. Radioactive decay
45. At resonance, the phase angle in an a.c. circuit is
 A. 90° B. 60°
 C. 0° D. 180°
46. The force on a current carrying conductor in a magnetic field is greatest when the
 A. Conductor make an angle of 60° with the field
 B. Force is independent of the angle between the field and the conductor
 C. Conductor is parallel with the field
 D. Conductor is at right angles with the field.
47. A transistor functions mainly as a
 A. Switch and an amplifier
 B. Rectifier and an amplifier
 C. Charge storer and an amplifier
 D. Charge storer and switch.
48. Energy losses through eddy currents are reduced by using
 A. Low resistance wires
 B. Insulated soft iron wires
 C. Few turns of wire
 D. High resistance wires
49. A capacitor of $20 \times 10^{-12}\text{F}$ and an inductor are joined in series.. the value of the inductance that will give the circuit a resonant frequency of 200 kHz is
 A. $\frac{1}{16}$ H
 B. $\frac{1}{8}$ H

- C. $\frac{1}{64} H$
 D. $\frac{1}{32} H$
 [$\pi^2 = 10$]

- B. Independent of the magnitude of the charge
 C. Proportional to the velocity v only
 D. Proportional to the magnitude of the charge only.

50. The magnetic force on a charged particle moving with velocity v is
 A. Proportional to both the magnitude of the charge and the velocity

Physics 2002

1. Which of the following is the correct shape of the velocity-time graph of a spherical steel ball dropped into a viscous fluid in a tall cylinder?

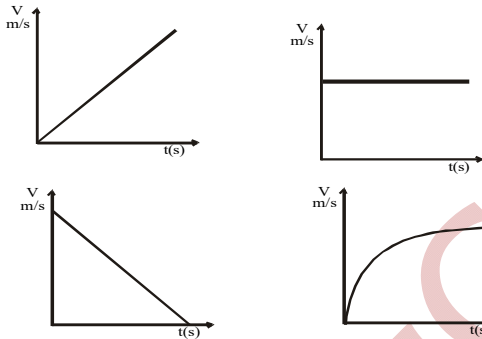

2. A particle in circular motion performs 30 oscillations in 6 seconds. Its angular velocity is
 A. 6 rad s^{-1} B. $5\pi \text{ rad s}^{-1}$
 C. $10\pi \text{ rad s}^{-1}$ D. 5 rad s^{-1}

3. A copper cube weights 0.25N in air, 0.17N when completely immersed in paraffin oil and 0.15N when completely immersed in water. The ratio of upthrust in oil to upthrust in water is
 A. 13 : 10 B. 7 : 10
 C. 3 : 5 D. 4 : 5

4. The hydrostatic blood pressure difference between the head and feet of a boy standing straight is $1.65 \times 10^4 \text{ Nm}^{-2}$. Find the height of the boy.
 A. 1.5m B. 2.0m
 C. 0.6m D. 0.5m
 [Den: sity of blood = $1.1 \times 10^3 \text{ kgm}^{-3}$, $g = 10 \text{ ms}^{-2}$]

5. If the total force acting on a particle is zero, the linear momentum will
 A. Be constant B. Increase
 C. Increase then decrease
 D. Decrease

6. The effect of a particle in a fluid attaining its terminal velocity is that the
 A. Buoyancy force is more than the weight of the fluid displaced
 B. Buoyancy force is equal to the viscous retarding force
 C. Acceleration is maximum
 D. Weighting is equal to the retarding force.

7.

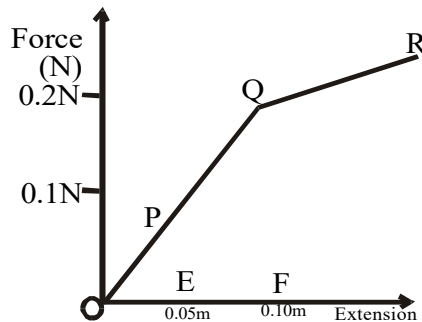

The diagram above shows the force-extension curve of a piece of wire. The energy stored when the wire is stretched from E to F is

- A. $1.5 \times 10^{-2} \text{ J}$ B. $7.5 \times 10^{-3} \text{ J}$
 C. $7.5 \times 10^{-1} \text{ J}$ D. $2.5 \times 10^{-3} \text{ J}$

8. If the distance between two suspended masses 10kg each is tripled, the gravitational force of attraction between them is reduced by
 A. One ninth B. One quarter
 C. One third D. One half

9. A wheel and axle is used to raise a load of 500 N by the application of an effort of 250N. If the radii of the wheel and the axle are 0.4cm and 0.1cm respectively, the efficiency of the machine is
 A. 50% B. 60%
 C. 20% D. 40%

10.

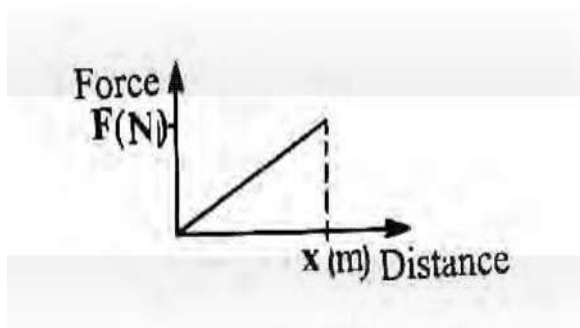

The diagram above shows the force (F) acting on an object through a distance (x). The work done on this object is expressed as

- A. $\frac{F}{x}$ J
 B. Fx^2 J
 C. $\frac{Fx}{2}$ J
 D. Fx J
11. A body weighting 80 N stands in an elevator that is about to move. The force exerted by the floor on the body as the elevator moves upwards with an acceleration of 5ms^{-2} is
 A. 120N
 B. 40N
 C. 160N
 D. 80N
 [g = 10ms^{-2}]
12. Two forces each of 10N act on a body, one towards north and the other towards the east. The magnitude and the direction of the resultant force are
 A. 20N, 45° W
 B. $10\sqrt{2}$ N, 45° W
 C. $10\sqrt{2}$ N, 45° E
 D. 20N, 45° E
13. A ray of light which strikes a glass slab from air at normal incidence passes through the slab
 A. Undeviated and displaced at a faster speed
 B. Undeviated and undisplaced at a lower speed
 C. Deviated and undisplaced at a lower speed
 D. Deviated and displaced at a lower speed.
14. Which of the following is a characteristic of stationary waves?
 A. The distance between two successive nodes is one wavelength.
 B. They are formed by two identical waves traveling in opposite directions.
 C. The antinode is a point minimum displacement.
 D. They can be transverse or longitudinal.
15. Which of the following eye defects can be corrected using a cylindrical lens?

- A. Presbyopia
 B. Chromatic aberration
 C. Myopia
 D. Astigmatism

16. The property that is propagated in traveling wave is
 A. Amplitude
 B. Wavelength
 C. Frequency
 D. Energy
17. A concave mirror of radius of curvature 40 cm forms a real image twice as large as the object. The object distance is
 A. 60 cm
 B. 40 cm
 C. 30 cm
 D. 10 cm
18. If tension is maintained on a stretched string of length 0.6m, such that its fundamental frequency of 220 Hz is excited, determine the velocity of the transverse wave in the string.
 A. 264ms^{-1}
 B. 132ms^{-1}
 C. 66ms^{-1}
 D. 528ms^{-1}
19. The radiator of a motor car is cooled by
 A. Radiation and conduction
 B. Radiation
 C. Conduction
 D. Convection
20. A coin placed below a rectangular glass block of thickness 9cm and refractive index 1.5 is viewed vertically above the block. The apparent displacement of the coin is
 A. 5 cm
 B. 3 cm
 C. 8 cm
 D. 6 cm
21. Blowing air over a liquid aids evaporation by
 A. Decreasing its vapour pressure
 B. Decreasing its density
 C. Increasing its surface area
 D. Increasing its temperature
22. The pressure of 3 moles of an ideal gas at a temperature of 27°C having a volume of 10^{-3}m^3 is
 A. $7.47 \times 10^5\text{Nm}^{-2}$
 B. $2.49 \times 10^6\text{Nm}^{-2}$
 C. $7.47 \times 10^6\text{Nm}^{-2}$
 D. $2.49 \times 10^5\text{Nm}^{-2}$
 [R = $8.3\text{J mol}^{-1}\text{K}^{-1}$]
23. To produce an enlarged and erect image with a concave mirror, the object must be positioned
 A. Between the principal focus and the pole
 B. Between the principal focus and the centre of curvature
 C. Beyond the centre of curvature
 D. At the principal focus.

24. The colours seen in soap bubbles are due to
 A. Refraction B. Diffraction
 C. Interference D. Dispersion
25. The phenomenon that makes sound persist when its source has been removed is known as
 A. Reverberation
 B. Acoustic vibration
 C. Rarefaction
 D. Echo
26. Vibrations in a stretched spring cannot be polarized because they are
 A. Longitudinal wave
 B. Mechanical waves
 C. Stationery waves
 D. Transverse waves.
27. I. Temperature
 II. Density of air molecules
 III. Pressure
 IV. Pitch
 Which of the above will affect the velocity of sound air?
 A. I, II and IV only B. I and II only
 C. I, II, III and IV D. II and IV only.
28. Water is poor thermometric liquid because it
 A. Wets glass
 B. Has low vapour pressure
 C. Is opaque
 D. Is a poor conductor
29. The time rate of loss of heat by a body is proportional to the
 A. Temperature of its surroundings
 B. Difference in temperature between the body and its surrounding
 C. Temperature of the body
 D. Ratio of the temperature of the body to that of its surrounding.
30. An electric iron is rated 1 000 W, 230 V. What is the resistance of its element?
 A. 57.6 Ohms B. 55.9 Ohms
 C. 51.9 Ohms D. 52.9 Ohms

31.

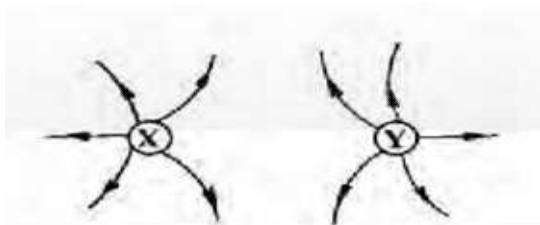

The electric field between the two-point charges

- is shown in the diagram above. What types of charges are at X and Y?
 A. Both X and Y are positive
 B. X is positive and Y is negative
 C. X is negative and Y is positive
 D. Both X and Y are negative.

32. The eye controls the amount of light reaching the retina by adjusting the
 A. Iris B. Optic nerve
 C. Cornea D. Retina
33. An electric cell with nominal voltage E has a resistance of 3 Ohms connected across it. If the voltage falls to 0.6Volts, the internal resistance of the cell is
 A. 2 Ohms B. 4 Ohms
 C. 1 Ohms D. 3 Ohms
34. When connected to a mains 250V, the fuse rating in the plug of an electric device of 1kW is
 A. 5 A B. 4 A
 C. 3 A D. 2 A
35. The electromagnetic wave that can produce a heating effect on the environment is
 A. Gamma rays B. X-rays
 C. Ultraviolet rays D. Infrared rays.
36. The energy stored in a capacitor of capacitance 10uF carrying a charge pf 100uC is
 A. 5×10^{-4} J B. 4×10^{-3} J
 C. 4×10^2 J D. 5×10^4 J
- 37.

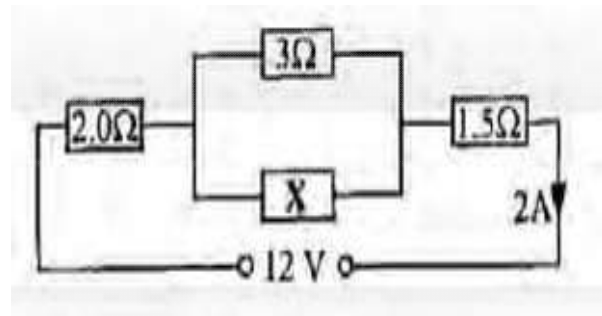

From the diagram above, determine the value of the resistance X

- A. 15 Ohms B. 12 Ohms
 C. 9 Ohms D. 6 Ohms

3

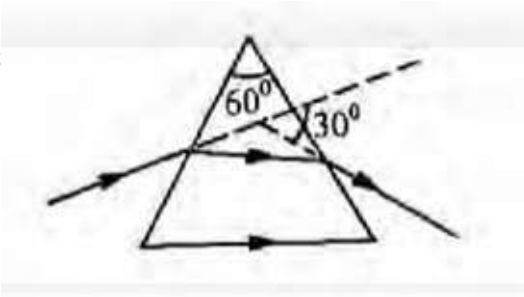

Calculate the refractive index of the material for the glass prism in the diagram above.

- A. $\frac{3}{2}$
- B. $\frac{4}{3}$
- C. $\frac{\sqrt{2}}{2}$
- D. $\sqrt{2}$

39. The particle that is responsible for nuclear fission in a nuclear reactor is

- A. Electron
- B. Neutron
- C. Photon
- D. Proton

40. At what frequency would a capacitor of 2.5uF used in a radio circuit have a reactance of 250Ohms?

- A. 200π Hz
- B. $\frac{\pi}{800}$ Hz
- C. 2000π Hz
- D. $\frac{800}{\pi}$ Hz

41. The percentage of the original nuclei of a sample of a radioactive substance left after 5 half-lives is

- A. 1 %
- B. 3 %
- C. 5 %
- D. 8 %

42. A current of 0.5 A flowing for 3 h deposits 2g of a metal during electrolysis.. the quantity of the same metal that would be deposited by a current of 1.5 A flowing in 1h is

- A. 18 g
- B. 10 g
- C. 6 g
- D. 2 g

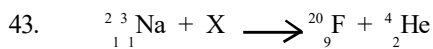

What particle is X in the reaction above?

- A. Neutron
- B. Alpha
- C. Gamma
- D. Beta

44. A transistor is used in the amplification of signals because it

- A. Allows doping
- B. Controls the flow current

- C. Contains electron and hole carriers
- D. Consumes a lot of power

45. Which of the following statements is true of the properties of a moving coil galvanometer?

- A. It has a small number of turns of coil
- B. There is a strong permanent magnet to give high magnetic flux
- C. The coil ha a small area.
- D. There are strong hair springs to give a large control couple

46. Pure silicon can be converted to a p-type material by adding a controlled amount of

- A. Pentavalent atoms
- B. Trivalent atoms
- C. Hexavalent atoms
- D. Tetravalent atoms

47. From the generating station to each substation power is transmitted at a very high voltage so as to reduce

- A. Heating in the coils
- B. Magnetic flux leakage
- C. Hysteresis loss
- D. Eddy current loss.

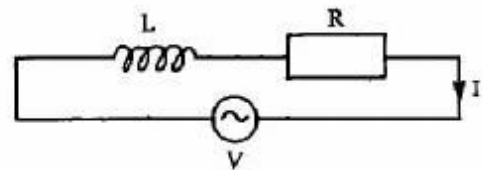

Which of the following graphs shows the correct vector diagram for the circuit above?

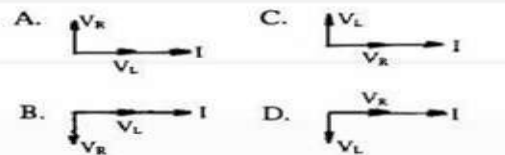

49. The energy associated with the photon of a radio transmission at 3×10^5 Hz is

- A. 2.00×10^{-29} J
- B. 2.00×10^{-28} J
- C. 1.30×10^{-29} J
- D. 1.30×10^{-28} J

50. The carbon-granule microphone works on the principle of change in

- A. Capacitance
- B. Voltage
- C. Inductance
- D. Resistance

Physics 2003

1.

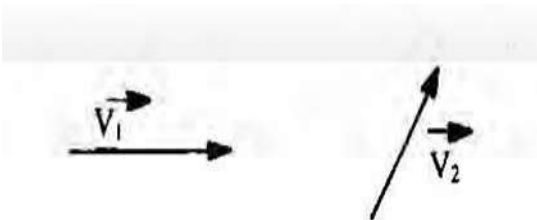

The figure above shows two velocities v_1 and v_2 . Which of the following diagrams correctly represents the vector difference $w = v_1 - v_2$?

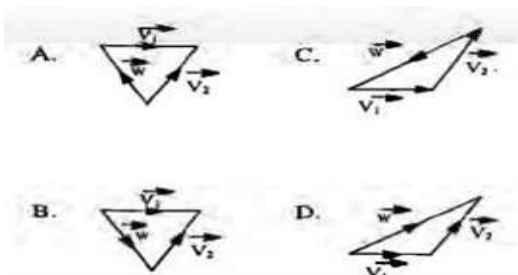

2.

If an object just begins to slide on a surface inclined at 30° to the horizontal, the coefficient of friction is

- A. $\frac{1}{\sqrt{3}}$
- B. $\frac{1}{\sqrt{3}}$
- C. $\sqrt{3}$
- D. $\frac{3}{\sqrt{3}}$

3.

A satellite is in a parking orbit if its period is

- A. More than the period of the earth
- B. Equal to the period of the earth
- C. The square of the period of the earth
- D. Less than the period of the earth

4.

What does not drop through an open umbrella of silk material unless the inside of the umbrella is touched

- A. Osmotic pressure
- B. Capillarity
- C. Surface tension
- D. Viscosity

5.

A bead traveling on a straight wire is brought to rest at 0.2m by friction. If the mass of the bead is 0.01kg and the coefficient of friction between the

bead and the wire is 0.1, determine the work done by the friction

- A. $2 \times 10^{-3} \text{ J}$
- B. $2 \times 10^2 \text{ J}$
- C. $2 \times 10^{-4} \text{ J}$
- D. $2 \times 10^1 \text{ J}$

[$g = 10 \text{ ms}^{-2}$]

6.

The stylus of a phonograph record exerts a force of $77. \times 10^{-2} \text{ N}$ on a groove of radius 10^{-5} m . Compute the pressure exerted by the stylus on the groove.

- A. $2.42 \times 10^9 \text{ Nm}^{-2}$
- B. $4.90 \times 10^8 \text{ Nm}^{-2}$
- C. $2.45 \times 10^8 \text{ Nm}^{-2}$
- D. $3.45 \times 10^8 \text{ Nm}^{-2}$

7.

A piece of stone attached to one end of a string is whirled round in a horizontal circle and the string suddenly cuts. The stone will fly off in a direction.

- A. Tangential to the circular path
- B. Perpendicular to the circular path
- C. Towards the centre of the circle
- D. Parallel to the circular path.

8.



The length of a piece of glass block was measured of a vernier caliper as shown above. The length of the glass block is

- A. 1.65 cm
- B. 1.64 cm
- C. 1.66 cm
- D. 1.63 cm

9.

A test tube of radius 1.0cm is loaded to 8.8g. If it is placed upright in water, find the depth to which it would sink.

- A. 25.2 cm
- B. 2.8 cm
- C. 28.0 cm
- D. 5.2 cm

[$g = 10 \text{ ms}^{-2}$ density of water 1000 kgm^{-3}].

10.

A 90cm uniform lever has a load of 30N suspended at 15cm from one of its ends. If the fulcrum is at the centre of gravity, the force that must be applied at its other end to keep it in horizontal equilibrium is

- A. 20N
- B. 30N
- C. 60N
- D. 15N

11. On top of a spiral spring of force constant 500 Nm^{-1} is placed a mass of $5 \times 10^{-3} \text{ kg}$. If the spring is compressed downwards by a length of 0.02 m and then released, calculate the height to which the mass is projected
- A. 2m B. 8m
C. 1m D. 4m
12. A hose of cross-sectional area 0.5 m^2 is used to discharge water from a water tank at a velocity of 60 ms^{-1} in 20s into a container. If the container is filled completely, the volume of the container is
- A. 600 m^3 B. 6000 m^3
C. 240 m^3 D. 2400 m^3
13. A force of 100 N is used to kick a football of mass 0.8 kg . Find the velocity with which the ball moves if it takes 0.8 s to be kicked.
- A. 100 ms^{-1} B. 32 ms^{-1}
C. 50 ms^{-1} D. 64 ms^{-1}
14. The phenomenon whereby the water droplets in the atmosphere combine with dust particles in the air to reduce visibility is
- A. Fog B. Hail
C. Mist D. Cloud
15. Given that Young's modulus for aluminium is $7.0 \times 10^{10} \text{ Nm}^{-2}$ and density is $2.7 \times 10^3 \text{ kgm}^{-3}$. Find the speed of the sound produced if a solid bar is struck at one end with a hammer?
- A. $3.6 \times 10^3 \text{ ms}^{-1}$ B. $5.1 \times 10^3 \text{ ms}^{-1}$
C. $2.8 \times 10^3 \text{ ms}^{-1}$ D. $4.2 \times 10^3 \text{ ms}^{-1}$
16. Thermal equilibrium between two objects exists when
- A. The heat capacities of both objects are the same
B. One object loses heat continuously to the other
C. The temperatures of both objects are equal
D. The quantity of heat in both objects is the same.
17. If the distance from a point source of sound is doubled, by what factor does the density decrease?
- A. 2.00 B. 0.25
C. 4.00 D. 0.50
18. If an object is placed between two parallel plane mirrors with their reflecting surfaces facing each other, how many images of the object will be formed?
- A. Four B. Two
C. Eight D. infinite
19. A 2000 W electric heater is used to heat a metal object of mass 5 kg initially at 10°C . If a temperature rise of 30°C is obtained after 10 min, the heat capacity of the material is
- A. $1.2 \times 10^4 \text{ J}^\circ \text{C}^{-1}$
B. $6.0 \times 10^4 \text{ J}^\circ \text{C}^{-1}$
C. $8.0 \times 10^3 \text{ J}^\circ \text{C}^{-1}$
D. $4.0 \times 10^4 \text{ J}^\circ \text{C}^{-1}$
20. By what factor will the size of an object placed 10 cm from a convex lens be increased if the image is seen on a screen placed 25 cm from the lens?
- A. 2.5 B. 1.5
C. 0.4 D. 15.0
21. On a fairly cool rainy day when the temperature is 20°C , the length of a steel railroad track is 20 m . What will be its length on a hot dry day when the temperature is 40°C ?
- A. 20.009 m B. 20.002 m
C. 20.013 m D. 20.004 m
22. If $1.2 \times 10^6 \text{ J}$ of heat energy is given off in 1 sec. From a vessel maintained at a temperature gradient of 30 km^{-1} , the surface area of the vessel is
- A. $1.0 \times 10^3 \text{ m}^2$
B. $1.0 \times 10^2 \text{ m}^2$
C. $9.0 \times 10^4 \text{ m}^2$
D. $9.0 \times 10^2 \text{ m}^2$
[Thermal conductivity of the vessel = $400 \text{ Wm}^{-1} \text{ K}^{-1}$]
- 23.
- | $T/^\circ \text{C}$ | 0 | 5 | 10 | 15 | 20 | 40 | 60 |
|---------------------|------|------|------|-------|-------|-------|--------|
| S.V.P.(mmHg) | 4.58 | 6.51 | 8.94 | 12.67 | 17.50 | 55.10 | 149.00 |
- The table above shows the saturation vapour pressure against temperature in a certain town. If the vapour pressure in this town at 20°C is 10 mmHg , what is the relative humidity?
- A. 57.0% B. 17.5%
C. 10.0% D. 170.0%
24. At what position will an object be placed in front of a concave mirror in order to obtain an image at infinity?
- A. At centre of curvature
B. Between the principal focus and the centre of curvature
C. At the pole of the mirror
D. At the principal focus
25. An open pipe closed at one end produces its first fundamental note. If the velocity of sound in air is v and l the length of the pipe, the frequency of the note is
- A. $v/2l$ B. $2v/l$
C. $v/5l$ D. $v/4l$

26. A tuning fork of frequency 340Hz is vibrating just above a cylindrical tube of height 1.2m. If water is slowly poured into the tube, At what maximum height will resonance occur?
 A. 0.45m B. 0.95m
 C. 0.60m D. 0.50m
 [Speed of sound in air = 340ms⁻¹]

27. A wire of 5 ohms resistance is drawn out so that its new length is two times the original length. If the resistivity of the wire remains the same and the cross-sectional area is halved, the new resistance is
 A. 20 Ohms
 B. 5 Ohms
 C. 40 Ohms
 D. 10 Ohms

28. A ray incident on a glass prism undergoes minimum deviation when the
 A. Refraction angle equals 90°
 B. Incident angle is equal to the angle of refraction
 C. Incident angle is equal to the angle of emergence
 D. Incident angle equals 90°

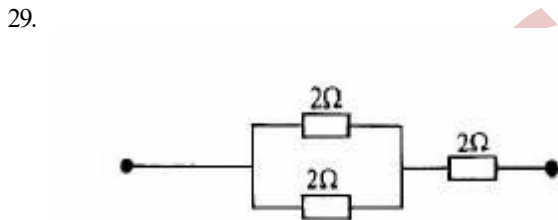

In the diagram above, if each of the resistors can dissipate a maximum of 18W without becoming excessively heated, what is the maximum power the circuit can dissipate?

- A. 9 W B. 27 W
 C. 5 W D. 18 W
30. I. It retains its magnetism much longer than steel
 II. it is more easily magnetized than steel
 III. It is more easily demagnetized than steel
 IV. It produces a stronger magnet than steel.
 Which combination of the above makes iron preferable to steel in the making of electromagnets?
 A. II, III and IV only
 B. I, III and IV only
 C. I and II only
 D. II and III only

31. Which of the following pairs of light rays shows the widest separation in the spectrum of white light?
 A. Green and yellow
 B. Indigo and violet
 C. Orange and red
 D. Blue and red

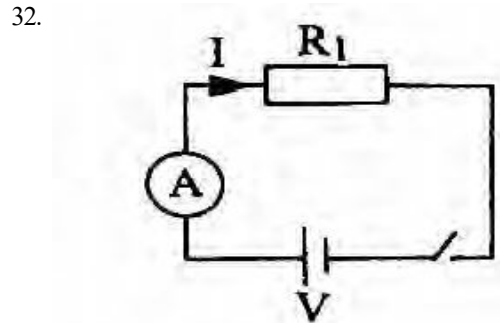

In the diagram above, what would happen to the current, I, if another resistor, R₂ is connected in parallel to R₁?

- A. It will decrease if R₂ is greater than R₁.
 B. It will increase because the equivalent resistance will increase.
 C. It will decrease if R₂ is less than R₁.
 D. It will increase because the effective resistance will decrease.
33. A ray of light is incident on an equilateral triangular glass prism of refractive index 3/2. Calculate the angle through which the ray is minimally deviated in the prism.
 A. 37.2° B. 48.6°
 C. 30.0° D. 42.0°

34. The most suitable cell used for short interval switches in electric bells is a
 A. Nickel iron accumulator
 B. Lead-acid accumulator
 C. Daniel cell
 D. Leclanche cell

35. An electron of charge 1.6 x 10⁻¹⁹C is accelerated between two metal plates. If the kinetic energy of the electron is 4.8 x 10⁻¹⁷J, the potential difference between the plates is
 A. 300V B. 30V
 C. 400V D. 40V

36. A magnetic field is said to exist at a point if a force is
 A. Deflection at the point
 B. Strengthened at the point
 C. Exerted on a moving charge at the point
 D. Exerted on a stationary charged at the point

37. The operation of an optical fibre is based on the principal of
- Polarization of light
 - Refraction of light
 - Interference of light
 - Dispersion of light
38. A positively charged rod X is brought near an uncharged metal sphere Y and is then touched by a finger with X still in place. When the finger is removed, the result is that Y has
- A negative charge and a positive potential
 - No charge and zero potential
 - A negative charge and a negative potential
 - A positive charge and a zero potential
39. In a semiconductor junction diode, as the depletion or barrier layer is forward-biased, the layer
- Narrows
 - Remains constant
 - Widens then narrows
 - Widen.
40. When a nucleus is formed by bringing protons and neutrons together, the actual mass of the formed nucleus is less than the sum of the masses of the constituent protons and neutrons. The energy equivalent of this mass difference is the
- Stability
 - Lost energy
 - Work function
 - Binding energy
41. An electron makes a transition from a certain energy level E_k to the ground state E_0 . If the frequency of emission is 8.0×10^{14} Hz, the energy emitted is
- 5.28×10^{19} J
 - 8.25×10^{19} J
 - 5.28×10^{-19} J
 - 8.25×10^{-19} J
42. In a fission process, the decrease in mass is 0.01%. How much energy could be obtained from the fission of 1.0g of the materials?
- 9.0×10^{10} J
 - 6.3×10^{11} J
 - 9.0×10^{11} J
 - 9.0×10^9 J
- [$c = 3.0 \times 10^8 \text{ms}^{-1}$]
43. A circuit has an area of 0.4m^2 and consists of 50 loops of wire. If the loops are twisted and allowed to rotate at a constant angular velocity of 10rads^{-1} in a uniform magnetic field of 0.4T, the amplitude of the induced voltage is
- 80V
 - 20V
 - 8V
 - 16V
44. When an alternating current given by $i = 10 \sin(120\pi t)$ passes through a 12 ohms resistor, the power dissipated in the resistor is
- 120W
 - 20W
 - 600W
 - 1200W
45. The major difference between a pure semiconductor and a pure metal is that
- The resistance of a metals increases with temperature, while for semiconductors, it is the reverse
 - Metals are harder than semiconductors
 - Metals have forbidden gaps while semiconductors have not
 - While the resistance of metals decrease with temperature, the reverse is the case for semiconductors.
46. If the uncertainty in the measurement of the position of a particle is $5 \times 10^{-10} \text{m}$, the uncertainty in the momentum of the particle is
- $3.30 \times 10^{-44} \text{Ns}$
 - $3.30 \times 10^{-24} \text{Ns}$
 - $1.32 \times 10^{-44} \text{Ns}$
 - $1.32 \times 10^{-24} \text{Ns}$
- [$h = 6.6 \times 10^{-34} \text{Js}$]
47. In the calibration of an ammeter using Faraday's laws of electrolysis, the ammeter reading is kept constant at 1.20A. If 0.990g of copper is deposited in 40 minutes, the correction to be applied to the ammeter is
- 0.05A
 - 0.06A
 - 0.03A
 - 0.04A
- [c.c.c. of copper = $3.3 \times 10^{-4} \text{gC}^{-1}$]
48. The maximum kinetic energy of the photoelectrons emitted from a metal surface is 0.34eV. If the work function of the metal surface is 1.83eV, find the stopping potential
- 1.09V
 - 2.17V
 - 0.34V
 - 1.49V
49. The force on a charge moving with velocity v in a magnetic field B is half of the maximum force when the angle between v and B is
- 0°
 - 90°
 - 45°
 - 30°
50. The count rate of a radioactive material is 800 count/min. If the half-life of the material is 4 days, what would the count rate be 16 days later?
- 50 count/min
 - 25/ count/min
 - 200 count/min
 - 100 count/min.

Physics 2004

1.

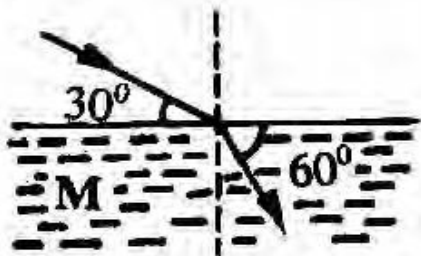

The refractive index of the medium M in the diagram above is

- A. $\frac{2}{\sqrt{3}}$ B. $\frac{1}{\sqrt{3}}$ C. $2\sqrt{3}$ D. $\sqrt{3}$

2.

What types of mirrors are capable of producing parallel beams of light such as those arising from the headlamps of a car?

- A. Cylindrical mirrors
B. Parabolic mirrors.
C. Spherical mirrors
D. Plane mirrors.

3.

A person can focus an object only when it lies within 200cm from him. Which spectacles should be used to increase his maximum distance of distinct vision to infinity?

- A. Concave lens B. Plane glasses
C. Binoculars. D. Convex lens

4.

In which of the following material media would sound travel faster?

- A. Water B. Oil
C. Metal D. Gas

5.

Calculate the angle of minimum deviation for a ray which is refracted through an equiangular prism of refractive index 1.4.

- A. 29° B. 60°
C. 99° D. 90°

6.

What happens to the rays in a parallel beam of light?

- A. They diverges as they travel
B. They meet at infinity
C. They intersect
D. They converge as they travel

magnification produced by a convex lens of focal length f ?

- A. $\frac{u}{v} + 1$ B. $\frac{u}{f} - 1$ C. $\frac{v}{f} - 1$
D. $\frac{v}{f} + 1$

8.

A ray of light make an angle of 35° with a plane mirror. What is the angle of reflection?

- A. 55° B. 35°
C. 70° D. 65°

9.

The pitch of a sound note depends on

- A. Timbre B. Harmonics
C. Quality D. frequency

10.

If the angle between two vectors P and Q is 0° , the vectors are said to

- A. Be perpendicular B. Be parallel
C. Intersect at angle 60°
D. Intersect at angle 45°

11.

A machine whose efficiency is 60% has a velocity ratio of 5. If a force of 500N is applied to lift a load P, what is the magnitude of P?

- A. 750N B. 4166N
C. 50N D. 1500N

12.

A body of mass 4kg is acted on by a constant force of 12N for 3 seconds. The kinetic energy gained by the body at the end of the time is

- A. 162J B. 144J
C. 72J D. 81J

13.

As the pressure of a fluid increase, its viscosity

- A. Decreased B. remains constant
C. Increases then decrease D. In crease.

14.

- I. Jet-propelled aircraft
II. Rocket propulsion
III. The recoil of a gun
IV. A person walking

Which of the above is based on Newton's third law of motion?

- A. I, II, III and IV B. I and III only
C. I and II only D. I, II and III only

15.

In a hydraulic press, a force of 40N is applied on the effort piston area 0.4m^2 . If the force exerted on the load piston is 400N, the area of the large piston is

- A. 8m^2 B. 4m^2
 C. 2m^2 D. 1m^2
16. A 100kg box is pushed along a road with a force of 500N. If the box moves with a uniform velocity, the coefficient of friction between the box and the road is
- A. 0.5 B. 0.4
 C. 10 D. 0.8
 [g = 10ms⁻²]
17. The earth is four times the size of the moon and the acceleration due to gravity on the earth is 80 times that on the moon. The ratio of the mass of the moon to that of the earth is
- A. 1 : 320 B. 1 : 1280
 C. 1 : 80 D. 1 : 4

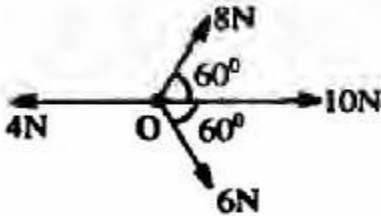

- The diagram above shows forces 4N, 6N, 10N and 8N which act at a point O in directions indicated. The net horizontal force is
- A. $\sqrt{3}\text{N}$ B. 17N
 C. $\sqrt{3}\text{N}$ D. 13N
19. A radioisotope has a decay constant of 10^{-7}s^{-1} . The average life of the radioisotope is
- A. $6.93 \times 10^8\text{s}$ B. $1.00 \times 10^{-7}\text{s}$
 C. $1.00 \times 10^7\text{s}$ D. $6.93 \times 10^7\text{s}$
20. A moving-coil galvanometer has a full-scale deflection of 3A equivalent to 30° deflection. Then sensitivity of the instrument is
- A. 10.0 B. 33.0
 C. 90.0 D. 0.1
21. The binding energy of helium ${}^4_2\text{He}$ is
- A. 2.017U B. 0.033U
 C. 4.033U D. 0.330U
 [atomic mass of proton = 1.00783U,
 atomic mass of neutron = 1.00867U]
22. In a tuned radio receiver R, L, C series circuit for resonance, the inductive and capacitive reactance X_L and X_C respectively are related as
- A. $X_L = \frac{1}{X_C}$ B. $X_L = \frac{1}{2}X_C$
 C. $X_L = X_C$ D. $X_L = 2X_C$

23. The particle and wave nature of matter are demonstrated in the equation
- A. $\lambda = \frac{h}{P}$ B. $\lambda = \frac{c}{f}$
 C. $\lambda = 2d \sin Q$ D. $\lambda = \frac{hc}{E}$
24. For semiconductors to have negative temperature coefficient of resistance implies that
- A. They have electrons and holes at high temperatures
 B. Their resistance is constantly changing with temperature
 C. Their resistance increases with temperature
 D. Their resistance decreases with temperature
25. Fluorescent tubes produce light by the
- A. Refraction of light by gas molecules
 B. Excitation of gas molecules
 C. Conduction of solar energy
 D. Thermal agitation of electrons in the tube.
26. In a reverse biased junction diode, current flows in by
- A. Electrons alone B. Majority carriers
 C. Minority carriers D. Positive holes alone
27. The energy stored in an inductor of inductance 5mH when a current of 6A flows through it is
- A. $1.8 \times 10^{-2}\text{J}$ B. $9.0 \times 10^{-3}\text{J}$
 C. $1.4 \times 10^{-2}\text{J}$ D. $9.0 \times 10^{-2}\text{J}$
28. X-rays can be used in the study of crystal structures because they
- A. Have an extremely short wavelength
 B. Have-a-very-long-reaching wavelength
 C. Are very fast
 D. Are invisible.
29. An a.c. circuit of e.m.f. 12V has a resistor of resistance 8 Ohms connected in series to an inductor of inductive reactance 16 Ohms and a capacitor of capacitive 10 Ohms. The current flow in the circuit is
- A. 1.4A B. 14.0A C. 1.2A D. 12.0A
30. A generator-manufacturing company was contracted to produce an a.c. dynamo but inadvertently produced a d.c. dynamo. To correct this error, the
- A. Commutator should be replace with slip rings.
 B. Commutator should be replace with slit rings
 C. Armature coil should be made aluminium
 D. Armature coil should be made silver.

31. Transverse waves can be distinguished from longitudinal waves using the characteristic of
- A. Diffraction B. Polarization
C. Reflection D. Refraction.

32. When left in a freezer, a bottle full of water cracks on freezing into ice because of the
- A. Decreases in the volume of water
B. Contraction of the bottle
C. Expansion of the bottle
D. Increase in the volume of water

34. The change in volume when 450kg of ice is completely melted is
- A. 0.05m^3 B. 0.45m^3
C. 4.50m^3 D. 0.50m^3
- [density of ice = 900kgm^{-3}
density of water = $1\,000\text{kgm}^{-3}$]

35. If a force of 50N stretches a wire from 20m to 20.01m, what is the amount of force required to stretch the same material from 20m to 20.05m?
- A. 100N B. 50N
C. 250N D. 200N

36. Tea pots are often silver-coated to prevent heat loss by
- A. Convection and conduction
B. Radiation only
C. Conduction only
D. Convection only.

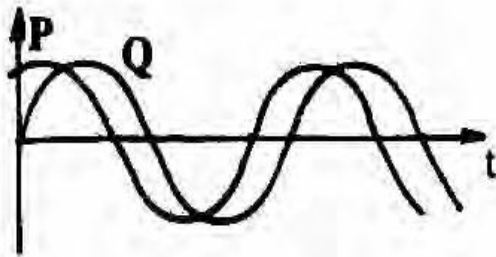

The phase difference between waves P and Q in the diagram above is

- A. $\frac{\pi}{2}$ B. 2π
C. $\frac{\pi}{4}$ D. π
38. Metal rods of length 20cm each are laid end to end to form a bridge at 25°C . What gap will be provided between consecutive rails for the bridge to withstand 75°C ?
- A. 0.22m B. 0.25m

- C. 0.02m D. 0.20m
[Linear expansivity of the material = $2.0 \times 10^{-5}\text{K}^{-1}$]

39. A 50W electric heater is used to heat a metal block of mass 5kg. If in 10minutes, a temperature rise of 120°C is achieved, the specific heat capacity of the metal is
- A. $500\text{J kg}^{-1}\text{K}^{-1}$ B. $130\text{J kg}^{-1}\text{K}^{-1}$
C. $390\text{J kg}^{-1}\text{K}^{-1}$ D. $400\text{J kg}^{-1}\text{K}^{-1}$

40. I. Wavelength
II. Medium of propagation
III. Wave velocity
IV. Frequency
V. Energy
- Which of the above are used for characterizing waves?
- A. I, II and V. B. II, IV and V
C. I and IV D. I, III and IV

41. The instrument used for securing a large number of similar charges by induction is called
- A. Capacitor B. Electrophorus
C. Electroscope D. Proof-plane

42. A steady current 2A flows in a coil of e.m.f. 12V for 0.4s. A back e.m.f. of 3V was induced during this period. The stored energy in the loop that can be utilized is
- A. 7.2J B. 12.0J
C. 2.4J D. 9.6J

43. If 16mA of current flows through a conductor in one second, the number of electrons transported per second is
- A. 1.00×10^{20} B. 1.00×10^{17}
C. 2.54×10^{-17} D. 2.56×10^{-18}
- [1 electronic charge = $1.6 \times 10^{-19}\text{C}$]

44. The difference between x-rays and gamma rays is that
- A. X-rays arise from energy changes in the electronic structure of atoms while gamma rays come from the nucleus.
B. X-rays are electromagnetic radiations while gamma rays are negatively charged radiations.
C. X-rays have higher frequencies than gamma rays
D. X-rays are more penetrating than gamma rays.

45.

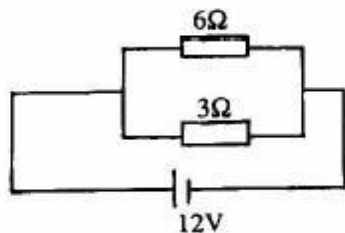

In the diagram above, the ratio of the electric power dissipated in the 6 Ohms and 3 Ohms resistors respectively is

- A. 2 : 3 B. 1 : 2
C. 1 : 3 D. 2 : 1
46. To protect a material from the influence of an external magnetic field, the material should be kept in a
A. Square steel ring B. Loop of copper wire
C. Triangular zinc ring D. Soft iron ring.
47. Which of the following is an electrolyte?
A. Grape juice B. Sugar solution
C. Alcohol D. Paraffin
48. Electrical appliances in homes are normally earthed so that
A. Both the a.c. and d.c. sources can be used
B. A person touching the appliances is safe from electric shock
C. The appliances are maintained at a higher p.d. than the earth
D. The appliances are maintained at a lower p.d. than the earth
49. A cell whose internal resistance is 0.5 Ohms delivers a current of 4A to an external resistor. The lost voltage of the cell is
A. 1.250V B. 8.000V
C. 0.125V D. 2.000V
50. Given three capacitors 0.3uF, 0.5 uF and 0.2 uF, the joint capacitance when arranged to give minimum capacitance is
A. 0.3uF B. 1.0uF
C. 0.1uF D. 0.5uF

This past question was successful uploaded by [Olanik Consultancy](http://www.myedugist.com). You can also visit the site www.myedugist.com for latest information on Examination, Education and Scholarships worldwide.